

150 MHz Mixed Signal CombiScope[®] HM1508

Manual

English

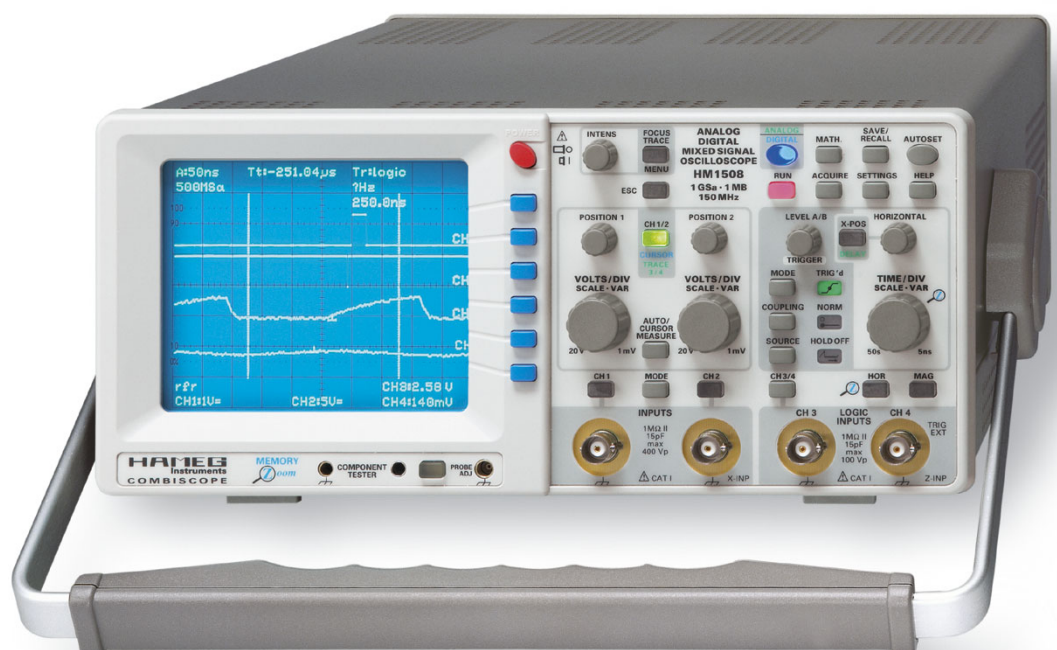



Hersteller
Manufacturer
Fabricant

HAMEG Instruments GmbH
Industriestraße 6
D-63533 Mainhausen

KONFORMITÄTSERKLÄRUNG
DECLARATION OF CONFORMITY
DECLARATION DE CONFORMITE

HAMEG[®]
Instruments

Die HAMEG Instruments GmbH bescheinigt die Konformität für das Produkt
The HAMEG Instruments GmbH herewith declares conformity of the product
HAMEG Instruments GmbH déclare la conformité du produit

Bezeichnung / Product name / Designation:

Oszilloskop
Oscilloscope
Oscilloscope

Typ / Type / Type:

HM1508

mit / with / avec:

-

Optionen / Options / Options:

-

mit den folgenden Bestimmungen / with applicable regulations / avec les directives suivantes

EMV Richtlinie 89/336/EWG ergänzt durch 91/263/EWG, 92/31/EWG
EMC Directive 89/336/EEC amended by 91/263/EWG, 92/31/EEC
Directive EMC 89/336/CEE amendée par 91/263/EWG, 92/31/CEE

Niederspannungsrichtlinie 73/23/EWG ergänzt durch 93/68/EWG
Low-Voltage Equipment Directive 73/23/EEC amended by 93/68/EEC
Directive des équipements basse tension 73/23/CEE amendée par 93/68/CEE

Angewendete harmonisierte Normen / Harmonized standards applied / Normes harmonisées utilisées:

Sicherheit / Safety / Sécurité: EN 61010-1:2001 (IEC 61010-1:2001)
Überspannungskategorie / Overvoltage category / Catégorie de surtension: II
Verschmutzungsgrad / Degree of pollution / Degré de pollution: 2

Elektromagnetische Verträglichkeit / Electromagnetic compatibility /
Compatibilité électromagnétique

EN 61326-1/A1 Störaussendung / Radiation / Emission:
Tabelle / table / tableau 4; Klasse / Class / Classe B.

Störfestigkeit / Immunity / Imunité: Tabelle / table / tableau A1.

EN 61000-3-2/A14 Oberschwingungsströme / Harmonic current emissions /
Émissions de courant harmonique:
Klasse / Class / Classe D.

EN 61000-3-3 Spannungsschwankungen u. Flicker / Voltage fluctuations and flicker /
Fluctuations de tension et du flicker.

Datum /Date /Date
24. 02. 2005

Unterschrift / Signature / Signatur

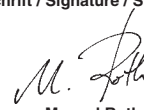
Manuel Roth
Manager

General information regarding the CE marking

HAMEG instruments fulfill the regulations of the EMC directive. The conformity test made by HAMEG is based on the actual generic- and product standards. In cases where different limit values are applicable, HAMEG applies the severer standard. For emission the limits for residential, commercial and light industry are applied. Regarding the immunity (susceptibility) the limits for industrial environment have been used.

The measuring- and data lines of the instrument have much influence on emission and immunity and therefore on meeting the acceptance limits. For different applications the lines and/or cables used may be different. For measurement operation the following hints and conditions regarding emission and immunity should be observed:

1. Data cables

For the connection between instruments resp. their interfaces and external devices, (computer, printer etc.) sufficiently screened cables must be used. Without a special instruction in the manual for a reduced cable length, the maximum cable length of a dataline must be less than 3 meters and not be used outside buildings. If an interface has several connectors only one connector must have a connection to a cable.

Basically interconnections must have a double screening. For IEEE-bus purposes the double screened cables HZ72S and HZ72L from HAMEG are suitable.

2. Signal cables

Basically test leads for signal interconnection between test point and instrument should be as short as possible. Without instruction in the manual for a shorter length, signal lines must be less than 3 meters and not be used outside buildings.

Signal lines must be screened (coaxial cable - RG58/U). A proper ground connection is required. In combination with signal generators double screened cables (RG223/U, RG214/U) must be used.

3. Influence on measuring instruments

Under the presence of strong high frequency electric or magnetic fields, even with careful setup of the measuring equipment an influence of such signals is unavoidable.

This will not cause damage or put the instrument out of operation. Small deviations of the measuring value (reading) exceeding the instruments specifications may result from such conditions in individual cases.

4. RF immunity of oscilloscopes.

4.1 Electromagnetic RF field

The influence of electric and magnetic RF fields may become visible (e.g. RF superimposed), if the field intensity is high. In most cases the coupling into the oscilloscope takes place via the device under test, mains/line supply, test leads, control cables and/or radiation. The device under test as well as the oscilloscope may be effected by such fields.

Although the interior of the oscilloscope is screened by the cabinet, direct radiation can occur via the CRT gap. As the bandwidth of each amplifier stage is higher than the total -3dB bandwidth of the oscilloscope, the influence RF fields of even higher frequencies may be noticeable.

4.2 Electrical fast transients / electrostatic discharge

Electrical fast transient signals (burst) may be coupled into the oscilloscope directly via the mains/line supply, or indirectly via test leads and/or control cables. Due to the high trigger and input sensitivity of the oscilloscopes, such normally high signals may effect the trigger unit and/or may become visible on the CRT, which is unavoidable. These effects can also be caused by direct or indirect electrostatic discharge.

HAMEG Instruments GmbH

General information regarding the CE marking	2	AUTOSET	19
150 MHz Mixed Signal CombiScope® HM1508	4	Component tester	19
Specifications	5	CombiScope	21
Important hints	6	DSO Operation	22
List of symbols used:	6	DSO operating modes	22
Positioning the instrument	6	Memory resolution	22
Safety	6	Memory depth	23
Proper operation	6	Horizontal resolution with X magnifier	23
CAT I	6	Maximum signal frequency in DSO mode	23
Environment of use.	6	Display of aliases	23
Environmental conditions	7	Vertical amplifier operating modes	23
Warranty and repair	7	Data transfer	23
Maintenance	7	HO710: RS-232 Interface, Remote control	24
Line voltage	7	Selection of Baud rate	24
Description of the controls	8	Data transmission	24
Basic signal measurement	10	Loading of new firmware	24
Signals which can be measured	10	General information concerning MENU	25
Amplitude of signals	10	Controls and Readout	26
Values of a sine wave signal	10		
DC and ac components of an input signal	11		
Timing relationships	11		
Connection of signals	11		
First time operation and initial adjustments	12		
Trace rotation TR	12		
Probe adjustment and use	12		
1 kHz adjustment	12		
1 MHz adjustment	13		
Operating modes of the vertical amplifier	13		
XY operation	14		
Phase measurements with Lissajous figures	14		
Measurement of phase differences in dual channel Yt mode	14		
Measurement of amplitude modulation	15		
Triggering and time base	15		
Automatic peak triggering (MODE menu)	15		
Normal trigger mode (See menu MODE)	16		
Slope selection (Menu FILTER)	16		
Trigger coupling (Menu: FILTER)	16		
Video (tv triggering)	16		
Frame sync pulse triggering	17		
Line sync pulse triggering	17		
LINE trigger	17		
Alternate trigger	17		
External triggering	17		
Indication of triggered operation (TRIG'D LED)	17		
Hold-off time adjustment	17		
Time base B (2nd time base). Delaying, Delayed Sweep. Analog mode.	18		
Alternate sweep	18		

150 MHz Mixed Signal CombiScope® HM1508

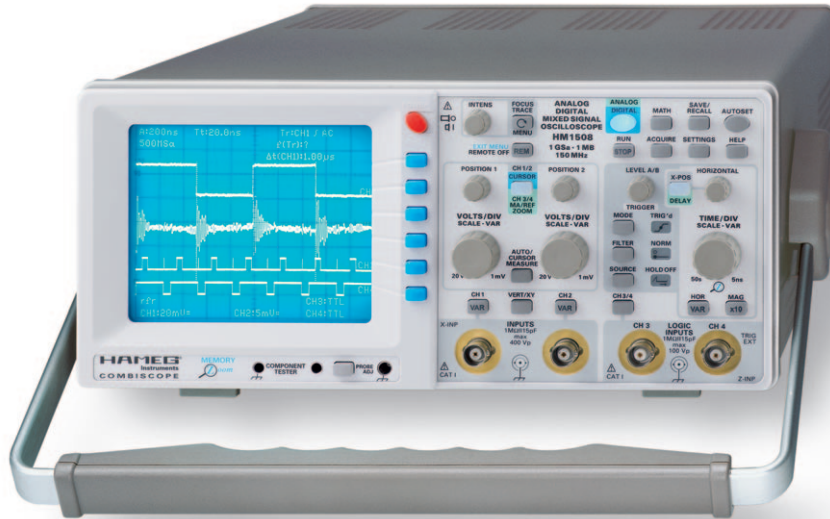

Digital Mode: Display of 4 signals (2 analog and 2 logic signals)

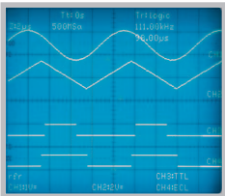

Digital Mode: One complete TV line and a ZOOM magnified sector (PAL Burst)

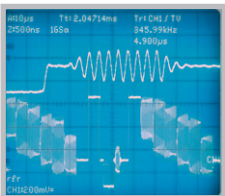

High fidelity even in digital mode: Low noise signals displayed without additional noise

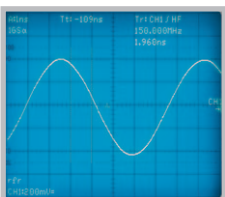

1 GSa/s Real Time Sampling, 10 GSa/s Random Sampling
1 MPts memory per channel allows Memory Zoom up to 50,000:1

4 Channels (2 Analog, 2 Logic)

Pre-/Post-Trigger - 100 % to +400 %

8-Bit Low Noise Flash A/D Converters

Time Base 50 s/cm – 5 ns/cm

Acquisition modes: Single Event, Refresh, Average, Envelope, Roll, Peak-Detect

RS-232 Interface, optional: RS-232/USB, IEEE-488, Ethernet/USB

Signal display: Yt and XY;

Interpolation: Sinx/x, Pulse, Dot Join (linear)



150 MHz Mixed Signal CombiScope® HM1508

Valid at 23 °C after a 30 minute warm-up period

Vertical Deflection

Channels:	
Analog:	2
Digital:	2 + 2 Logic Channels
Operating Modes:	
Analog:	CH 1 or CH 2 separate, DUAL (CH 1 and CH 2 alternate or chopped), Addition
Digital:	Analog Signal Channels CH 1 or CH 2 separate, DUAL (CH 1 and CH 2), Addition Logic Signal Channels: CH 3 and CH 4
X in XY-Mode:	CH 1
Invert:	CH 1, CH 2
Bandwidth [-3 dB]:	2 x 0 - 150 MHz
Rise time:	< 2.3 ns
Overshoot:	max. 1 %
Bandwidth limiting [selectable]:	about 20 MHz [5 mV/cm - 20V/cm]
Deflection Coefficients(CH 1,2):	14 calibrated steps
1 mV - 2 mV/cm (10 MHz)	± 5 % [0 - 10 MHz [-3 dB]]
5 mV - 20 V/cm	± 3 % [1-2-5 sequence]
variable [uncalibrated]:	> 2.5:1 to > 50V/cm
Inputs CH 1, 2:	
Impedance:	1 MΩ 15 pF
Coupling:	DC, AC, GND (ground)
Max. Input Voltage:	400 V (DC + peak AC)
Y Delay Line (analog):	70 ns
Measuring Circuits:	Measuring Category I
Digital mode only:	
Logic Channels:	CH 3, CH 4
Select. switching thresholds:	TTL, CMOS, ECL
User definable thresholds:	3
within the range:	-2 V to +3 V
Analog mode only:	
Auxiliary input:	CH 4: 100V (DC + peak AC)
Function [selectable]:	Extern Trigger, Z [unblank]
Coupling:	AC, DC
Max. input voltage:	100V (DC + peak AC)
Triggering	
Analog and Digital Mode	
Automatic (Peak to Peak):	
Min. signal height:	5 mm
Frequency range:	10 Hz - 250 MHz
Level control range:	from Peak- to Peak+
Normal (without peak):	
Min. signal height:	5 mm
Frequency range:	0 - 250 MHz
Level control range:	-10 cm to +10 cm
Operating modes:	Slope/Video/Logic
Slope:	positive, negative, both
Sources:	CH 1, CH 2, alt. CH 1/2 (≥ 8 mm), Line, Ext.
Coupling:	AC: 10 Hz-250 MHz DC: 0-250 MHz HF: 30 kHz-250 MHz LF: 0-5 kHz
	Noise Rej. switchable
Video:	
Standards:	pos./neg. Sync. Impulse 525 Line/60 Hz Systems 625 Line/50 Hz Systems
Field:	even/odd/both
Line:	all/line number selectable
Source:	CH 1, CH 2, Ext.
Indicator for trigger action:	LED
External Trigger via:	CH 4 [0.3 V _{pp} , 150 MHz]
Coupling:	AC, DC
Max. input voltage:	100V (DC +peak AC)
Digital mode:	
Logic:	AND/OR, TRUE/FALSE
Source:	CH1 or 2, CH3 and CH4
State:	X, H, L
Pre/Post Trigger:	-100 % to +400 % related to complete memory
Analog mode	
2nd Trigger	
Min. signal height:	5 mm
Frequency range:	0 - 250 MHz
Coupling:	DC
Level control range:	-10 cm to +10 cm
Horizontal Deflection	
Analog mode	
Operating modes:	A, ALT (alternating A/B), B
Time base A:	0.5 s/cm - 50 ns/cm (1-2-5 sequence)
Time base B:	20 ms/cm - 50 ns/cm (1-2-5 sequence)

Accuracy A and B:	± 3 %
X Magnification x10:	to 5 ns/cm
Accuracy:	± 5 %
Variable time base A/B:	cont. 1:2.5
Hold Off time:	var. 1:10 LED-Indication
Bandwidth X-Amplifier:	0 - 3 MHz [-3 dB]
X Y phase shift < 3°:	< 220 kHz

Digital mode

Time base range (1-2-5 sequence)	
Refresh Mode:	20 ms/cm - 5 ns/cm
with Peak Detect:	20 ms/cm - 2 ms/cm (min. Pulse Width 10 ns)
Roll Mode:	50 s/cm - 50 ms/cm
Accuracy time base	
Time base:	50 ppm
Display:	± 1 %
MEMORY ZOOM:	max. 50,000:1
Bandwidth X-Amplifier:	0 - 150 MHz [-3 dB]
XY phase shift < 3°:	< 100 MHz

Digital Storage

Acquisition (real time):	Analog channels: 2 x 500 MSa/s, 1 GSa/s interleaved; Logic Channels: 2 x 500 MSa/s
Acquisition (random sampling):	10 GSa/s
Bandwidth:	2 x 0 - 150 MHz (random)
Memory:	1 M-Samples per channel
Operating modes:	Refresh, Average, Envelope/ Roll: Free Run/Triggered, Peak-Detect
Resolution (vertical):	8 Bit [25 Pts/cm]
Resolution (horizontal):	
Yt:	11 Bit [200 Pts/cm]
XY:	8 Bit [25 Pts /cm]
Interpolation:	Sinx/x, Dot Join (linear), Pulse
Delay:	1 Million * 1/Sampling Rate to 4 Million * 1/Sampling Rate
Display refresh rate:	max.170/s at 1 MPts
Display:	Dots [acquired points only], Vectors (partly interpolated), optimal (complete memory weighting and vectors)
Reference Memories:	9 with 2 kPts each (for recorded signals)
Display:	2 signals of 9 [free selectable]

Operation/Measuring/Interfaces

Operation:	Menu (multilingual), Autoset, help functions (multilingual)
Save/Recall (instrument parameter settings):	9
Signal display:	max. 4 signals or 4 traces
analog:	CH 1, 2 (Time Base A) in combination with CH 1, 2 (Time Base B)
digital:	CH 1, 2 and CH 3, 4 or ZOOM or Reference or Mathematics)
Frequency counter:	
6 digit resolution:	>1 MHz - 250 MHz
5 digit resolution:	0.5 Hz - 1 MHz
Accuracy:	50 ppm
Auto Measurements:	
Analog mode:	Frequency, Period, Vdc, Vpp, Vp+, Vp-
also in digital mode:	V _{rms} , V _{avg}
Cursor Measurements:	
Analog mode:	Δt, 1/Δt (f), t _r , ΔV, V to GND, ratio X, ratio Y
plus in digital mode:	V _{pp} , V _{p+} , V _{p-} , V _{avg} , V _{rms} , pulse count
Resolution Readout/Cursor:	1000 x 2000 Pts, Signals: 250 x 2000
Interfaces (plug-in):	RS-232 (H0710)
Optional:	IEEE-488, Ethernet, Dual-Interface RS-232/USB

Mathematic functions

Number of Formula Sets:	5 with 5 formulas each
Sources:	CH 1, CH 2, Math 1-Math 5
Targets:	5 math. memories, Math 1-5
Functions:	ADD, SUB, 1/X, ABS, MUL, DIV, SQ, POS, NEG, INV
Display:	max. 2 math. memories (Math 1-5)

Display

CRT:	D14-375GH
Display area (with graticule):	8 cm x 10 cm
Acceleration voltage:	approx. 14 kV

General Information

Component tester	
Test voltage:	approx. 7 V _{rms} (open circuit), approx. 50 Hz
Test current:	max. 7 mA _{rms} (short circuit)
Reference Potential :	Ground (safety earth)
Probe ADJ Output:	1 kHz/1 MHz square wave signal 0.2V _{pp} (tr < 4 ns)
Trace rotation:	electronic
Line voltage:	105 - 253 V, 50/60 Hz ± 10 %, CAT II
Power consumption:	47 Watt at 230V, 50 Hz
Protective system:	Safety class I (EN61010-1)
Weight:	5.6 kg
Cabinet (W x H x D):	285 x 125 x 380 mm
Ambient temperature:	0° C ...+40° C

Accessories supplied: Line cord, Operating manual, 4 Probes 10:1 with attenuation ID, Windows Software for control and data transfer

Optional accessories: Dual-Interface RS-232/USB H0720, Ethernet H0730, IEEE-488 (GPIB) H0740, Opto-Interface (with optical fiber cable) HZ70

Important hints

Please check the instrument for mechanical damage or loose parts immediately after unpacking. In case of damage we advise to contact the sender. Do not operate.

List of symbols used:



Consult the manual



High voltage



Important note



Ground

Positioning the instrument

For selection of the optimum position in use the instrument may be set up in three different positions (see pictures C,D,E). The handle will remain locked in the carrying position if the instrument is positioned on its rear feet.

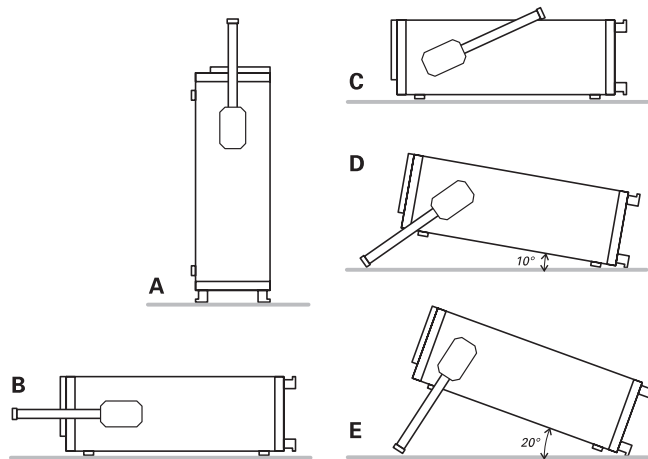

Move the handle to the instrument top if the horizontal operating position is preferred (See picture C). If a position corresponding the picture D (10 degrees inclination) is desired move the handle from the carrying position A towards the bottom until it engages and locks. In order to reach a position with still greater inclination (E shows 20 degrees) unlock the handle by pulling and move it further into the next locking position. For carrying the instrument in the horizontal position the handle can be locked horizontally by moving it upwards as shown in picture B. The instrument must be lifted while doing this, otherwise the handle will unlock again.

Safety

The instrument fulfils the VDE 0411 part 1 regulations for electrical measuring, control and laboratory instruments and was manufactured and tested accordingly. It left the factory in perfect safe condition. Hence it also corresponds to European Standard EN 61010-1 resp. International Standard IEC 1010-1. In order to maintain this condition and to ensure safe operation the user is required to observe the warnings and other directions for use in this manual. Housing, chassis as well as all measuring terminals are connected to safety ground of the mains. All accessible metal parts were tested against the mains with 2200 V_{DC}. The instrument conforms to safety class I.

The oscilloscope may only be operated from mains outlets with a safety ground connector. The plug has to be installed prior to

connecting any signals. It is prohibited to separate the safety ground connection.

Most electron tubes generate X rays; the ion dose rate of this instrument remains well below the 36 pA/kg permitted by law.

In case safe operation may not be guaranteed do not use the instrument any more and lock it away in a secure place.

Safe operation may be endangered if any of the following was noticed:

- in case of visible damage.
- in case loose parts were noticed
- if it does not function any more.
- after prolonged storage under unfavourable conditions (e.g. like in the open or in moist atmosphere).
- after any improper transport (e.g. insufficient packing not conforming to the minimum standards of post, rail or transport firm)

Proper operation

Please note: This instrument is only destined for use by personnel well instructed and familiar with the dangers of electrical measurements.

For safety reasons the oscilloscope may only be operated from mains outlets with safety ground connector. It is prohibited to separate the safety ground connection. The plug must be inserted prior to connecting any signals.

CAT I

This oscilloscope is destined for measurements in circuits not connected to the mains or only indirectly. Direct measurements, i.e. with a galvanic connection to circuits corresponding to the categories II, III, or IV are prohibited!

The measuring circuits are considered not connected to the mains if a suitable isolation transformer fulfilling safety class II is used. Measurements on the mains are also possible if suitable probes like current probes are used which fulfil the safety class II. The measurement category of such probes must be checked and observed.

Measurement categories

The measurement categories were derived corresponding to the distance from the power station and the transients to be expected hence. Transients are short, very fast voltage or current excursions which may be periodic or not.

Measurement cat. IV:

Measurements close to the power station, e.g. on electricity meters

Measurement cat. III:

Measurements in the interior of buildings (power distribution installations, mains outlets, motors which are permanently installed).

Measurement cat. II:

Measurements in circuits directly connected to the mains (household appliances, power tools etc).

Environment of use.

The oscilloscope is destined for operation in industrial, business, manufacturing, and living sites.

Environmental conditions

Operating ambient temperature: 0 to + 40 degrees C. During transport or storage the temperature may be -25 to +55 degrees C.

Please note that after exposure to such temperatures or in case of condensation proper time must be allowed until the instrument has reached the permissible range of 0 to + 40 degrees resp. until the condensation has evaporated before it may be turned on! Ordinarily this will be the case after 2 hours. The oscilloscope is destined for use in clean and dry environments. Do not operate in dusty or chemically aggressive atmosphere or if there is danger of explosion.

The operating position may be any, however, sufficient ventilation must be ensured (convection cooling). Prolonged operation requires the horizontal or inclined position.



Do not obstruct the ventilation holes!

Specifications are valid after a 20 minute warm-up period between 15 and 30 degr. C. Specifications without tolerances are average values.

Warranty and repair

HAMEG instruments are subjected to a rigorous quality control. Prior to shipment each instrument will be burnt-in for 10 hours. Intermittent operation will produce nearly all early failures. After burn-in a final functional and quality test will be performed which checks all operating modes and fulfilment of specifications.

In case of complaints within the 2 year warranty period please contact the distributor from which the instrument was bought. German customers may contact HAMEG directly. Our warranty policy may be obtained under www.hameg.de. Of course, HAMEG customer service will be at your disposal also after expiration of the warranty.

Return Material Authorization.

Prior to sending an instrument please obtain a RMA number form HAMEG either via www.hameg.de or by fax. In case you do not have an original packing you may order one by contacting HAMEG marketing and sales by phone +49-6182-800-300 or under vertrieb@hameg.de.

Maintenance

It is necessary to check various important properties of the oscilloscope regularly. Only this will ensure that all measurements will be exact within the instrument's specifications. We recommend a SCOPE TESTER HZ60 which, in spite of its low cost, will fulfil this requirement very well. Clean the outer shell using a dust brush in regular intervals. Dirt can be removed from housing, handle, all metal and plastic parts using a cloth moistened with water and 1 % detergent. Greasy dirt may be removed with benzene (petroleum ether) or alcohol, there after wipe the surfaces with a dry cloth. Plastic parts should be treated with an antistatic solution destined for such parts. No fluid may enter the instrument. Do not use other cleansing agents as they may adversely affect the plastic or lacquered surfaces.

Line voltage

The instrument has a wide range power supply from 105 to 253 V, 50 or 60 Hz $\pm 10\%$. There is hence no line voltage selector.

The line fuse is accessible on the rear panel and part of the line input connector. Prior to exchanging a fuse the line cord must be pulled out. Exchange is only allowed if the fuse holder is undamaged, it can be taken out using a screwdriver put into the slot. The fuse can be pushed out of its holder and exchanged.

The holder with the new fuse can then be pushed back in place against the spring. It is prohibited to "repair" blown fuses or to bridge the fuse. Any damages incurred by such measures will void the warranty.

Type of fuse:

Size 5 x 20 mm; 250V~, C;
IEC 127, Bl. III; DIN 41 662
(or DIN 41 571, Bl. 3).
Cut off: slow blow (T) 0,8A.

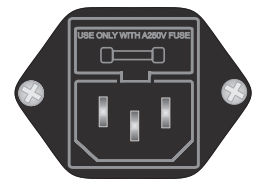

Front Panel Elements – Brief Description

The figures indicate the page for complete discription in the chapter CONTROLS AND READOUT ▼

① POWER (pushbutton switch)	26	⑰ VOLTS/DIV-SCALE-VAR (knob)	32
Turns scope on and off.		Channel 2 Y deflection coefficient, Y variabel and Y scaling setting.	
② INTENS (knob)	26	⑱ AUTO / CURSOR MEASURE (pushbutton switch)	33
Intensity for trace- and readout brightness, focus and trace rotation control.		Calls menus and submenus for automatic and cursor supported measurement.	
③ FOCUS, TRACE, MENU (pushbutton switch)	26	⑲ LEVEL A/B (knob)	34
Calls the Intensity Knob menu to be displayed and enables the change of different settings by aid of the INTENS knob. See item 2.		Trigger level control for time base A and B.	
④ REM (pushbutton switch)	26	⑳ MODE (pushbutton switch)	34
Switches the displayed menu, the remote mode (REM) lit off.		Calls selectable trigger modes.	
⑤ ANALOG/DIGITAL (pushbutton switch)	27	㉑ FILTER (pushbutton switch)	35
Switches between analog (green) and digital mode (blue).		Calls selectable trigger filter (coupling) and trigger slope menu.	
⑥ STOP / RUN (pushbutton switch)	27	㉒ SOURCE (pushbutton switch)	36
RUN: Signal data acquisition enabled. STOP: Signal data acquisition disabled. The result of the last acquisition is displayed.		Calls trigger source menu.	
⑦ MATH (pushbutton switch)	27	㉓ TRIG'd (LED)	37
Calls mathematical function menu if digital mode is present.		Lit on condition that time base is triggered.	
⑧ ACQUIRE (pushbutton switch)	28	㉔ NORM (LED)	37
Calls the signal capture and display mode menu in digital mode.		Lit on condition that NORMAL or SINGLE triggering is present.	
⑨ SAVE/RECALL (pushbutton switch)	29	㉕ HOLD OFF (LED)	37
Offers access to the reference signal (digital mode only) and the instrument settings memory.		Lit if a hold off time >0% is chosen in time base menu (HOR pushbutton ㉓).	
⑩ SETTINGS (pushbutton switch)	30	㉖ X-POS / DELAY (pushbutton switch)	37
Opens menu for language and miscellaneous function; in digital mode also signal display mode.		Calls and indicates the actual function of the HORIZONTAL knob ㉗, (X-POS = dark).	
⑪ AUTOSET (pushbutton switch)	30	㉗ HORIZONTAL (knob)	38
Enables appropriate, signal related, automatic instrument settings.		Changes the X position resp. in digital mode the delay time (Pre- resp. Post-Trigger).	
⑫ HELP (pushbutton switch)	31	㉘ TIME/DIV-SCALE-VAR (knob)	38
Switches help texts regarding controls and menus on and off.		Time base A and B deflection coefficient, time base variable and scaling control.	
⑬ POSITION 1 (knob)	31	㉙ MAG x10 (pushbutton switch)	38
Controls position of actual present functions: Signal (current, reference or mathematics), Cursor and ZOOM (digital).		10 fold expansion in X direction in Yt mode, with simultaneous change of the deflection coefficient display in the readout.	
⑭ POSITION 2 (knob)	31	㉚ HOR / VAR (pushbutton switch)	38
Controls position of actual present functions: Signal (current, reference or mathematics) Cursor and ZOOM (digital).		Calls ZOOM function (digital) and analog time base A and B, time base variable and hold off control.	
⑮ CH1/2-CURSOR-CH3/4-MA/REF-ZOOM (pushbutton)	32	㉛ CH1 / VAR (pushbutton switch)	40
Calls the menu and indicates the current function of POSITION 1 and 2 controls.		Calls channel 1 menu with input coupling, inverting, probe and Y variable control.	
⑯ VOLTS/DIV-SCALE-VAR (knob)	32	㉜ VERT/XY (pushbutton switch)	40
Channel 1 Y deflection coefficient, Y variabel and Y scaling setting.		Calls vertical mode selection, addition, XY mode and bandwidth limiter.	
		㉝ CH2 / VAR (pushbutton switch)	41
		Calls channel 1 menu with input coupling, inverting, probe and Y variable control.	
		㉞ CH1 (BNC-socket)	42
		Channel 1 signal input and input for horizontal deflection in XY mode.	

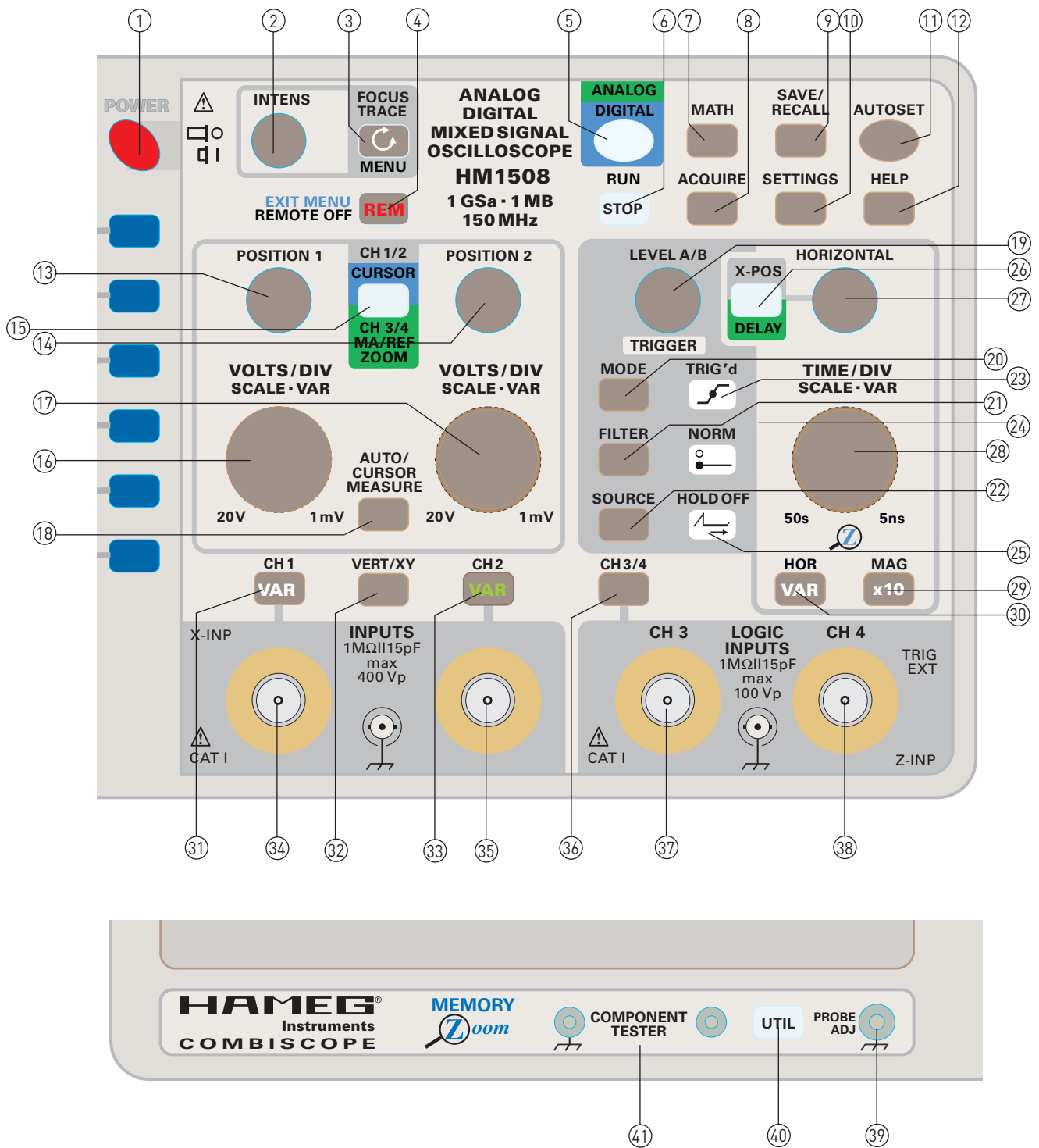

- ③⑤ CH2 [BNC-socket] 42
Channel 2 signal input.
- ③⑥ CH3/4 [pushbutton switch] 42
Digital mode: Logic signal channels 3 and 4. On condition OFF, CH4 becomes the external trigger input.
Analog mode: CH4 can be used for intensity modulation [Z] if external triggering is switched off.
- ③⑦ CH3 [BNC-socket] 43
Input for logic signals in digital mode.
- ③⑧ CH4 [BNC-socket] 43
Digital mode: Input for logic signals or external trigger signals. Analog mode: Input for intensity modulation [Z] or external trigger signals.
- ③⑨ PROBE / ADJ (socket) 43
Square wave signal output for frequency compensation of x10 probes.
- ④① PROBE / COMPONENT (pushbutton switch) 43
Calls COMPONENT TESTER mode settings and frequency selection of PROBE ADJ signal.
- ④② COMPONENT TESTER [2 sockets with 4 mm Ø] 43
Connectors for test leads of the Component Tester. Left socket is galvanically connected with protective earth.

Basic signal measurement

Signals which can be measured

The following description pertains as well to analog as to DSO operation. The different specifications in both operating modes should be kept in mind.

The oscilloscope HM 1508 can display all repetitive signals with a fundamental repetition frequency of at least 150 MHz. The frequency response is 0 to 150 MHz (-3 dB). The vertical amplifiers will not distort signals by overshoots, undershoots, ringing etc.

Simple electrical signals like sine waves from line frequency ripple to hf will be displayed without problems. However, when measuring sine waves, the amplitudes will be displayed with an error increasing with frequency. At 100 MHz the amplitude error will be around -10 %. As the bandwidths of individual instruments will show a certain spread (the 150 MHz are a guaranteed minimum) the actual measurement error for sine waves cannot be exactly determined.

Pulse signals contain harmonics of their fundamental frequency which must be represented, so the maximum useful repetition frequency of nonsinusoidal signals is much lower than 150 MHz. The criterion is the relationship between the rise times of the signal and the scope; the scope's rise time should be <math><1/3</math> of the signal's rise time if a faithful reproduction without too much rounding of the signal shape is to be preserved.

The display of a mixture of signals is especially difficult if it contains no single frequency with a higher amplitude than those of the other ones as the scope's trigger system normally reacts to a certain amplitude. This is e.g. typical of burst signals. Display of such signals may require using the HOLD-OFF control.

Composite video signals may be displayed easily as the instrument has a tv sync separator.

The maximum sweep speed of 5 ns/cm allows sufficient time resolution, e.g. a 100 MHz sine wave will be displayed one period per 2 cm.

The vertical amplifier inputs may be DC or AC coupled. Use DC coupling only if necessary and preferably with a probe.

Low frequency signals when AC coupled will show tilt (AC low frequency -3 dB point is 1.6 Hz), so if possible use DC coupling. Using a probe with 10:1 or higher attenuation will lower the -3 dB point by the probe factor. If a probe cannot be used due to the loss of sensitivity DC coupling the scope and an external large capacitor may help which, of course, must have a sufficient DC rating. Care must be taken, however, when charging and discharging a large capacitor.

DC coupling is preferable with all signals of varying duty cycle, otherwise the display will move up and down depending on the duty cycle. Of course, pure DC can only be measured with DC coupling.

The readout will show which coupling was chosen: = stands for DC, ~ stands for AC.

Amplitude of signals

In contrast to the general use of rms values in electrical engineering oscilloscopes are calibrated in V_{pp} as that is what is displayed.

Derive rms from V_{pp} : divide by 2.84. Derive V_{pp} from rms: multiply by 2.84.

Values of a sine wave signal

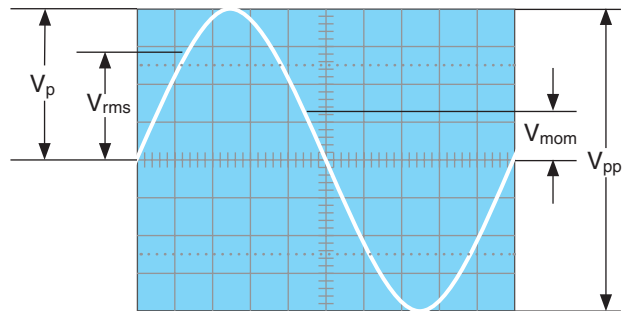

V_{rms} = rms value

V_{pp} = pp - value

V_{mom} = momentary value, depends on time vs. period.

The minimum signal for a one cm display is $1 \text{ mV}_{pp} \pm 5\%$ provided 1 mV/cm was selected and the variable is in the calibrated position.

The available sensitivities are given in mV_{pp} or V_{pp} . The cursors allow to indicate the amplitudes of the signals immediately on the readout as the attenuation of probes is automatically taken into account. Even if the probe attenuation was selected manually this will be overridden if the scope identifies a probe with an identification contact as different. The readout will always give the true amplitude.

It is important that the variable be in its calibrated position. The sensitivity may be continuously decreased by using the variable (see Controls and Readout). Each intermediate value between the calibrated positions 1-2-5 may be selected. Without using a probe thus a maximum of $400 V_{pp}$ may be displayed ($20 \text{ V/div} \times 8 \text{ cm screen} \times 2.5 \text{ variable}$).

Amplitudes may be directly read off the screen by measuring the height and multiplying by the V/div . setting.



Please note: Without a probe the maximum permissible voltage at the inputs must not exceed $400 V_p$ irrespective of polarity.

In case of signals with a DC content the peak value DC + AC peak must not exceed + or - $400 V_p$. Pure AC of up to $800 V_{pp}$ is permissible.



If probes are used their possibly higher ratings are only usable if the scope is DC coupled.

In case of measuring DC with a probe while the scope input is AC coupled the capacitor in the scope input will see the input DC voltage as it is in series with the internal $1 \text{ M}\Omega$ resistor. This means that the maximum DC voltage (or DC + peak AC) is that of the scope input, i.e. $400 V_p$! With signals which contain DC and AC the DC content will stress the input capacitor while the AC content will be divided depending on the AC impedance

of the capacitor. It may be assumed that this is negligible for frequencies >40 Hz.

Considering the foregoing you may measure DC signals of up to 400 V or pure AC signals of up to 800 V_{PP} with a HZ200 probe. Probes with higher attenuation like HZ53 100:1 allow to measure DC up to 1200 V and pure AC of up to 2400 V_{PP}. (Please note the derating for higher frequencies, consult the HZ53 manual). Stressing a 10:1 probe beyond its ratings will risk destruction of the capacitor bridging the input resistor with possible ensuing damage of the scope input!

In case the residual ripple of a high voltage is to be measured a high voltage capacitor may be inserted in front of a 10:1 probe, it will take most of the voltage as the value of the probe's internal capacitor is very low, 22 to 68 nF will be sufficient.

If the input selector is switched to Ground the reference trace on the screen may be positioned at graticule center or elsewhere.

DC and AC components of an input signal

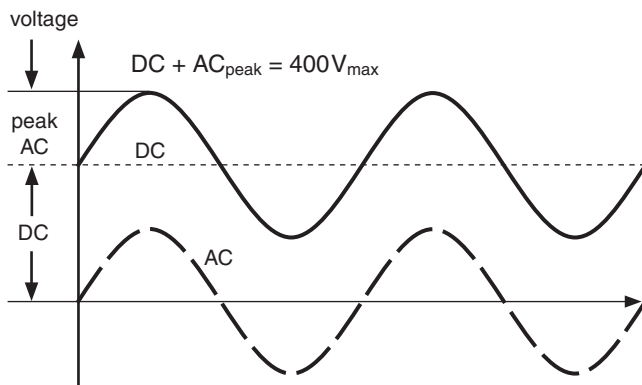

The dashed curve shows an AC signal symmetrical to zero. If there is a DC component the peak value will be DC + AC peak.

Timing relationships

The repetition frequency of a signal is equal to the number of periods per second. Depending on the TIME/DIV setting one or more periods or part of a period of the signal may be displayed. The time base settings will be indicated on the readout in s/cm, ms/cm, μs/cm and ns/cm. Also the cursors may be used to measure the frequency or the period.

If portions of the signal are to be measured use delayed sweep (analog mode) or zoom (DSO mode) or the magnifier x 10. Use the HORIZONTAL positioning control to shift the portion to be zoomed into the screen center.

Pulse signals are characterized by their rise and fall times which are measured between the 10 % and 90 % portions. The following example uses the internal graticule of the crt, but also the cursors may be used for measurement.

Measurement:

- Adjust the rising portion of the signal to 5 cm.
- Position the rising portion symmetrically to the graticule centre line, using both Y and X positioning controls.
- Notice the intersections of the signal with the 10 and 90 % lines and project these points to the centre line in order to read the time difference.

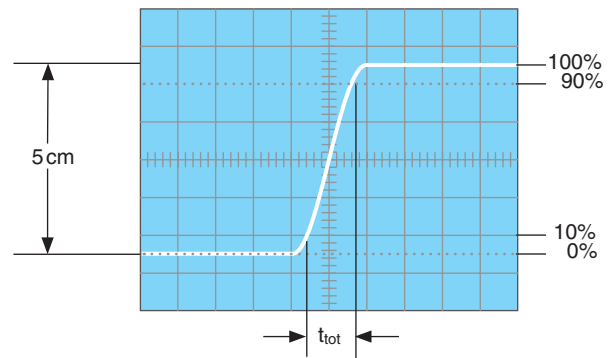

In the example it was 1.6 cm at 5 ns/cm equals 8 ns rise time.

When measuring very short rise times coming close to the scope rise time it is necessary to subtract the scope's (and if used the probe's) rise times geometrically from the rise time as seen on the screen. The true signal rise time will become:

$$t_a = \sqrt{t_{tot}^2 - t_{osc}^2 - t_t^2}$$

t_{tot} is the rise time seen, t_{osc} is the scope's own rise time [2.3 ns with the HM1508], t_t is the rise time of the probe, e.g. 2 ns. If the signal's rise time is > 22 ns, the rise times of scope and probe may be neglected.

$$t_a = \sqrt{8^2 - 2.3^2 - 2^2} = 7,4 \text{ ns}$$

For the measurement of rise times it is not necessary to proceed as outlined above. Rise times may be measured anywhere on the screen. It is mandatory that the rising portion of the signal be measured in full and that the 10 to 90 % are observed. In case of signals with over- or undershoot the 0 and 100 % levels are those of the horizontal portions of the signal, i.e. the over- resp. undershoots must be disregarded for rise and fall time measurements. Also, glitches will be disregarded. If signals are very distorted, however, rise and fall time measurements may be of no value.

For most amplifiers, even if their pulse behaviour is far from ideal, the following relationship holds:

$$t_a = \frac{350}{B} \quad B = \frac{350}{t_a}$$

$$tr/ns = 350/Bandwidth/MHz$$

Connection of signals

In most cases pressing the AUTOSET button will yield a satisfactory display (see AUTOSET). The following relates to special cases where manual settings will be advisable. For a description of controls refer to "Controls and Readout".

 **Take care when connecting unknown signals to the inputs!**

It is recommended to use probes whenever possible. Without a probe start with the attenuator set to its 20 V/cm position. If the trace disappears the signal amplitude may be too large overdriving the vertical amplifier or/and its DC content may be too high. Reduce the sensitivity until the trace will reappear onscreen. If calibrated measurements are desired it will be necessary to use a probe if the signal becomes >160 Vp. Check the probe specifications in order to avoid overstressing. If the time base is set too fast the trace may become invisible, then reduce the time base speed.

If no probe is used at least screened cable should be used, such as HZ32 or HZ34. However, this is only advisable for low

impedance sources or low frequencies (<50 kHz). With high frequencies impedance matching will be necessary.

Nonsinusoidal signals require impedance matching, at both ends preferably. At the scope input a feed through – 50Ω-termination will be required. HAMEG offers a HZ22 termination. If proper terminations are not used sizeable pulse aberrations will result. Also sine wave signals of > 100 kHz should be properly terminated. Most generators control signal amplitudes only if correctly terminated.

HZ22 may only be used up to 7 V_{rms} or 20 V_{pp} i.e. 1 W.

For probes terminations are neither required nor allowed, they would ruin the signal.

Probes feature very low loads at fairly low frequencies: 10 MΩ in parallel to a few pF, valid up to several hundred kHz. However, the input impedance diminishes with rising frequency to quite low values. This has to be borne in mind as probes are, e.g., entirely unsuitable to measure signals across high impedance high frequency circuits such as bandfilters etc.! Here only FET probes can be used. Use of a probe as a rule will also protect the scope input due to the high probe series resistance (9 MΩ). As probes cannot be calibrated exactly enough during manufacturing individual calibration with the scope input used is mandatory! (See Probe Calibration).

Passive probes will, as a rule, decrease the scope bandwidth resp. increase the rise time. We recommend to use HZ200 probes in order to make maximum use of the combined bandwidth. HZ200 features 2 additional hf compensation adjustments.

Whenever the DC content is > 400 V_{DC} coupling must be used in order to prevent overstressing the scope input capacitor. This is especially important if a 100:1 probe is used as this is specified for 1200 V_{DC} + peak AC.

AC coupling of low frequency signals may produce tilt.

If the DC content of a signal must be blocked it is possible to insert a capacitor of proper size and voltage rating in front of the probe, a typical application would be a ripple measurement.

When measuring small voltages the selection of the ground connection is of vital importance. It should be as close to voltage take-off point as possible, otherwise ground currents may deteriorate the measurement. The ground connections of probes are especially critical, they should be as short as possible and of large size.



If a probe is to be connected to a BNC connector use a probe tip to BNC adapter.

If ripple or other interference is visible, especially at high sensitivity, one possible reason may be multiple grounding. The scope itself and most other equipment are connected to safety ground, so ground loops may exist. Also, most instruments will have capacitors between line and safety ground installed which conduct current from the live wire into the safety ground.

First time operation and initial adjustments

Prior to first time operation the connection between the instrument and safety ground must be ensured, hence the plug must be inserted first.

Use the red pushbutton POWER to turn the scope on. Several displays will light up. The scope will then assume the set-up, which was selected before it was turned off. If no trace and no readout are visible after approximately 20 sec, push the AUTOSET button.

As soon as the trace becomes visible select an average intensity with INTENS, then select FOCUS and adjust it, then select TRACE ROTATION and adjust for a horizontal trace.

With respect to crt life use only as much intensity as necessary and convenient under given ambient light conditions, if unused turn the intensity fully off rather than turning the scope off and on too much, this is detrimental to the life of the crt heater. Do not allow a stationary point to stay, it might burn the crt phosphor.

With unknown signals start with the lowest sensitivity 20 V/cm, connect the input cables to the scope and then to the measuring object which should be deenergized in the beginning. Then turn the measuring object on. If the trace disappears, push AUTOSET.

Trace rotation TR

The crt has an internal graticule. In order to adjust the deflected beam with respect to this graticule the Trace Rotation control is provided. Select the function Trace Rotation and adjust for a trace which is exactly parallel to the graticule.

Probe adjustment and use

In order to ensure proper matching of the probe used to the scope input impedance the scope contains a calibrator with short rise time and an amplitude of 0.2 V_{pp} ± 1 %, equivalent to 4 cm at 5 mV/cm when using 10:1 probes.

The inner diameter of the calibrator connector is 4.9 mm and standardized for series F probes. Using this special connector is the only way to connect a probe to a fast signal source minimizing signal and ground lead lengths and to ensure true displays of pulse signals.

1 kHz – adjustment

This basic adjustment will ensure that the capacitive attenuation equals the resistive attenuation thus rendering the attenuation of the probe independent of frequency. 1:1 probes can not be adjusted and need no such adjustment anyway.

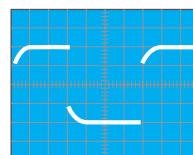

incorrect

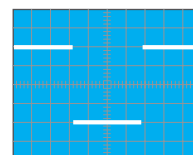

correct

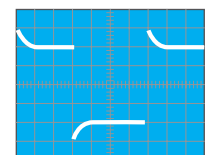

incorrect

Prior to adjustment make sure that the trace rotation adjustment was performed.

Connect the 10:1 probe to the input. Use DC coupling. Set the VOLTS/DIV to 5 mV/cm and TIME/DIV to 0.2 ms/cm, both calibrated. Insert the probe tip into the calibrator connector PROBE ADJ.

You should see 2 signal periods. Adjust the compensation capacitor (see the probe manual for the location) until the square wave tops are exactly parallel to the graticule lines (see picture 1 kHz). The signal height should be 4 cm ±1.6 mm (3% oscilloscope and 1% probe tolerance). The rising and falling portions of the square wave will be invisible.

1 MHz adjustment

The HAMEG probes feature additional adjustments in the compensation box which allow to optimise their hf behaviour. This adjustment is a precondition for achieving the maximum bandwidth with probe and a minimum of pulse aberrations.

This adjustment requires a calibrator with a short rise time (typ. 4 ns) and a 50Ω output, a frequency of 1 MHz, an amplitude of 0.2 V_{pp}. The PROBE ADJ. output of the scope fulfils these requirements.

Connect the probe to the scope input to which it is to be adjusted. Select the PROBE ADJ. signal 1 MHz. Select DC coupling and 5mV/cm with VOLTS/DIV. and 0.1 μs/cm with TIME/DIV., both calibrated. Insert the probe tip into the calibrator output connector. The screen should show the signal, rise and fall times will be visible. Watch the rising portion and the top left pulse corner, consult the manual for the location of the adjustments.

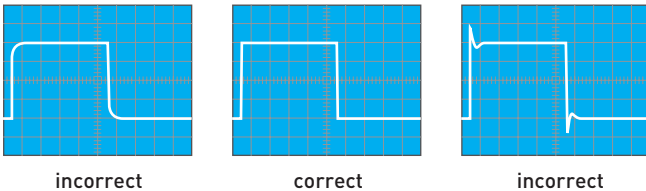

The criteria for a correct adjustment are:

- short rise time, steep slope.
- clean top left corner with minimum over- or undershoot, flat top.

After adjustment check the amplitude which should be the same as with 1 kHz.

It is important to first adjust 1 kHz, then 1 MHz. It may be necessary to check the 1 kHz adjustment again.

Please note that the calibrator signals are not calibrated with respect to frequency and thus must not be used to check the time base accuracy, also their duty cycle may differ from 1:1. The probe adjustment is completed if the pulse tops are horizontal and the amplitude calibration is correct.

Operating modes of the vertical amplifier

The controls most important for the vertical amplifier are: VERT/XY (2), CH 1 (3), CH 2 (3) – and in DSO mode also – CH3/4 (3). They give access to the menus containing the operating modes and the parameters of the individual channels.

Changing the operating mode is described in the chapter: "Controls and Readout".

Remark: Any reference to "both channels" always refers to channels 1 and 2.

Usually oscilloscopes are used in the Yt mode. In analog mode the amplitude of the measuring signal will deflect the trace vertically while a time base will deflect it from left to right.

The vertical amplifiers offer these modes:

- One signal only with CH1.
- One signal only with CH2.
- Two signals with channels 1 and 2 (DUAL trace mode)

In DSO mode the channels 3 and 4 are available in addition but for logic signals only.

In DUAL mode both channels are operative. In analog mode the method of signal display is governed by the time base (see also "Controls and Readout"). Channel switching may either take place after each sweep (alternate) or during sweeps with a high frequency (chopped).

The normal choice is alternate, however, at slow time base settings the channel switching will become visible and disturbing, when this occurs select the chopped mode in order to achieve a stable quiet display.

In DSO mode no channel switching is necessary as each input has its own A/D converter, signal acquisition is simultaneous.

In ADD mode the two channels 1 and 2 are algebraically added (±CH1 ±CH2). With + polarity the channel is normal, with - polarity inverted. If + Ch1 and - CH2 are selected the difference will be displayed or vice versa.

Same polarity input signals:

- Both channels not inverted: = sum
- Both channels inverted: = sum
- Only one channel inverted: = difference

Opposite polarity input signals:

- Both channels not inverted: = difference
- Both channels inverted: = difference
- One channel inverted: = sum.

Please note that in ADD mode both position controls will be operative. The INVERT function will not affect positioning.

Often the difference of two signals is to be measured at signal take-offs which are both at a high common mode potential. While this one typical application of the difference mode one important precaution has to be borne in mind: The oscilloscope vertical amplifiers are two separate amplifiers and do not constitute a true difference amplifier with as well a high CM rejection as a high permissible CM range! Therefore please observe the following rule: Always look at the two signals in the one channel only or the dual modes and make sure that they are within the permissible input signal range; this is the

case if they can be displayed in these modes. Only then switch to ADD. If this precaution is disregarded grossly false displays may result as the input range of one or both amplifiers may be exceeded.

Another precondition for obtaining true displays is the use of two identical probes at both inputs. But note that normal probe tolerances (percent) will cause the CM rejection to be expected to be rather moderate. In order to obtain the best possible results proceed as follows: First adjust both probes as carefully as possible, then select the same sensitivity at both inputs and then connect both probes to the output of a pulse generator with sufficient amplitude to yield a good display. Readjust one (!) of the probe adjustment capacitors for a minimum of over- or undershoot. As there is no adjustment provided with which the resistors can be matched a residual pulse signal will be unavoidable.

When making difference measurements it is good practice to first connect the ground cables of the probes to the object prior to connecting the probe tips. There may be high potentials between the object and the scope. If a probe tip is connected first there is danger of overstressing the probe or/and the scope inputs! Never perform difference measurements without both probe ground cables connected.

XY operation

This mode is accessed by VERT/XY Ⓢ > XY. In analog mode the time will be turned off. The channel 1 signal will deflect in X direction (X-INP. = horizontal input), hence the input attenuators, the variable and the POSITION 1 control will be operative. The HORIZONTAL control will also remain functional.

Channel 2 will deflect in Y direction.

The x10 magnifier will be inoperative in XY mode. Please note the differences in the Y and X bandwidths, the X amplifier has a lower -3 dB frequency than the Y amplifier. Consequently the phase difference between X and Y will increase with frequency.

In XY mode the X signal (CH1 = X-INP). can not be inverted.

The XY mode may generate Lissajous figures which simplify some measuring tasks and make others possible:

- Comparison of two signals of different frequency or adjustment of one frequency until it is equal to the other resp. becomes synchronized.
- This is also possible for multiples or fractions of one of the frequencies.

Phase measurements with Lissajous figures

The following pictures show two sine waves of equal amplitude and frequency but differing phase.

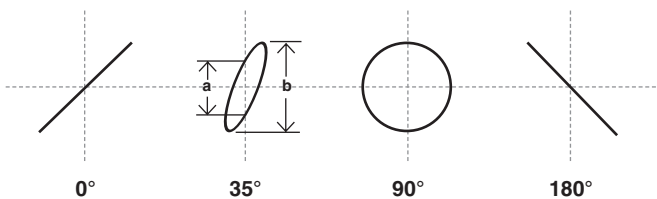

Calculation of the phase angle between the X- and Y-signals (after reading a and b off the screen) is possible using the following formulas and a pocket calculator with trigonometric functions. This calculation is independent of the signal amplitudes:

Please note:

- As the trigonometric functions are periodic limit the calculation to angles <90 degrees. This is where this function is most useful.
- Do not use too high frequencies, because, as explained above, the two amplifiers are not identical, their phase difference increases with frequency. The spec gives the frequency at which the phase difference will stay <3 degrees.

$$\sin \varphi = \frac{a}{b}$$

$$\cos \varphi = \sqrt{1 - \left(\frac{a}{b}\right)^2}$$

$$\varphi = \arcsin \frac{a}{b}$$
- The display will not show which of the two frequencies does lead or lag. Use a CR combination in front of the input of the frequency tested. As the input has a 1 MΩ resistor it will be sufficient to insert a suitable capacitor in series. If the ellipse increases with the C compared to the C short-circuited the test signal will lead and vice versa. This is only valid <90 degrees. Hence C should be large and just create a barely visible change.

If in XY mode one or both signals disappear, only a line or a point will appear, mostly very bright. In case of only a point there is danger of phosphor burn, so turn the intensity down immediately; if only a line is shown the danger of burn will increase the shorter the line is. Phosphor burn is permanent.

Measurement of phase differences in dual channel Yt mode

Please note: Do not use "alternate trigger" because the time differences shown are arbitrary and depend only on the respective signal shapes! Make it a rule to use alternate trigger only in rare special cases.

The best method of measuring time or phase differences is using the dual channel Yt mode. Of course, only times may be read off the screen, the phase must then be calculated as the frequency is known. This is a much more accurate and convenient method as the full bandwidth of the scope is used, and both amplifiers are almost identical. Trigger the time base from the signal which shall be the reference. It is necessary to position both traces without signal exactly on the graticule center (POSITION 1 and 2). The variables and trigger level controls may be used, this will not influence the time difference measurement. For best accuracy display only one period at high amplitude und observe the zero crossings. One period equals 360 degrees. It may be advantageous to use ac coupling if there is an offset in the signals.

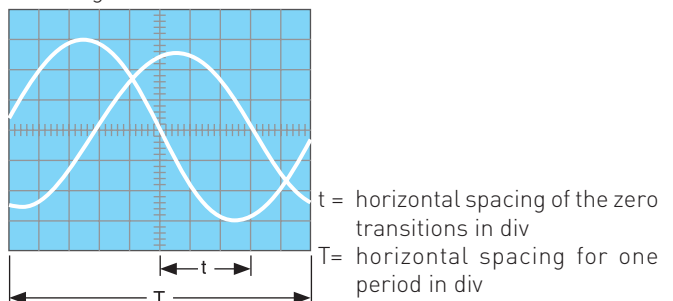

In this example $t = 3 \text{ cm}$ and $T = 10 \text{ cm}$, the phase difference in degrees will result from:

$$\varphi^\circ = \frac{5}{T} \cdot 360^\circ = \frac{3}{10} \cdot 360^\circ = 108^\circ$$

or in angular units:

$$\arcsin \varphi^\circ = \frac{t}{T} \cdot 2\pi = \frac{3}{10} \cdot 2\pi = 1,885 \text{ rad}$$

Very small phase differences with moderately high frequencies may yield better results with Lissajous figures.

However, in order to get higher precision it is possible to switch to higher sensitivities – after accurately positioning at graticule centre – thus overdriving the inputs resulting in sharper zero crossings. Also, it is possible to use half a period over the full 10 cm. As the time base is quite accurate increasing the time base speed after adjusting for e.g. one period = 10 cm and positioning the first crossing on the first graticule line will also give better resolution.

Measurement of amplitude modulation

Please note: Use this only in analog mode because in DSO mode alias displays may void the measurement! For the display of low modulation frequencies a slow time base (TIME/DIV) has to be selected in order to display one full period of the modulating signal. As the sampling frequency of any DSO must be reduced at slow time bases it may become too low for a true representation.

The momentary amplitude at time t of a hf carrier frequency modulated by a sinusoidal low frequency is given by:

$$u = U_T \cdot \sin \Omega t + 0,5m \cdot U_T \cdot \cos (\Omega - \omega) t - 0,5m \cdot U_T \cdot \cos (\Omega + \omega) t$$

- where:
- U_T = amplitude of the unmodulated carrier
 - Ω = $2\pi F$ = angular carrier frequency
 - ω = $2\pi f$ = modulation angular frequency
 - m = modulation degree ($\leq 1 \hat{=} 100\%$)

In addition to the carrier a lower side band $F - f$ and an upper side band $F + f$ will be generated by the modulation.

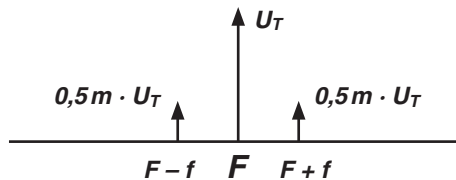

Picture 1: Amplitudes and frequencies with AM ($m = 50\%$) of the spectra

As long as the frequencies involved remain within the scope's bandwidth the amplitude-modulated hf can be displayed. Preferably the time base is adjusted so that several signal periods will be displayed. Triggering is best done from the modulation frequency. Sometimes a stable displayed can be achieved by twiddling with the time base variable.

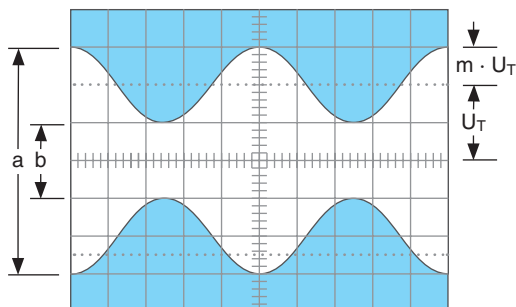

Picture 2: Amplitude modulated hf. $F = 1\text{ MHz}$, $f = 1\text{ kHz}$, $m = 50\%$, $U_T = 28,3\text{ mV}_{\text{rms}}$

Set the scope controls as follows in order to display the picture 2 signal:

- CH1 only, 20 mV/cm, AC
- TIME/DIV: 0.2 ms/cm
- Triggering: NORMAL, AC, internal.
- Use the time base variable or external triggering.

Reading a and b off the screen the modulation degree will result:

$$m = \frac{a-b}{a+b} \text{ bzw. } m = \frac{a-b}{a+b} \cdot 100 [\%]$$

$$a = U_T (1 + m) \text{ and } b = U_T (1 - m)$$

When measuring the modulation degree the amplitude and time variables can be used without any influence on the result.

Triggering and time base

The most important controls and displays for these functions are to be found in the shaded TRIGGER area, they are described in „Controls and Readout“.-

In YT mode the signal will deflect the trace vertically while the time will deflect it horizontally, the speed can be selected. In general periodic voltage signals are displayed with a periodically repeating time base. In order to have a stable display successive periods must trigger the time base at exactly the same time position of the signal (amplitude and slope).

 **Pure DC can not trigger the time base, a voltage change is necessary.**

Triggering may be internal from any of the input signals or externally from a time-related signal.

For triggering a minimum signal amplitude is required which can be determined with a sine wave signal. With internal triggering the trigger take-off within the vertical amplifiers is directly following the attenuators. The minimum amplitude is specified in mm on the screen. Thus it is not necessary to give a minimum voltage for each setting of the attenuator.

For external triggering the appropriate input connector is used, the amplitude necessary there is given in V_{pp} . The voltage for triggering may be much higher than the minimum, however, it should be limited to 20 times the minimum. Please note that for good triggering the voltage resp. signal height should be a good deal above the minimum. The scope features two trigger modes to be described in the following:

Automatic peak triggering (MODE menu)

Consult the chapters MODE $\textcircled{20}$ > AUTO, LEVEL A/B $\textcircled{19}$, FILTER $\textcircled{21}$ and SOURCE $\textcircled{22}$ in "Controls and Readout". Using AUTOSET this trigger mode will be automatically selected. With DC coupling and with alternate trigger this mode will be left while the automatic triggering will remain.

Automatic triggering causes a new time base start after the end of the foregoing and after the hold-off time has elapsed even

without any input signal. Thus there is always a visible trace in analog mode, and in DSO mode the trace will also be shown. The position of the trace(s) without any signal is then given by the settings of the POSITION controls.

As long as there is a signal scope operation will not need more than a correct amplitude and time base setting. With signals < 20 Hz their period is longer than the time the auto trigger circuit will wait for a new trigger, consequently the auto trigger circuit will start the time base then irrespective of the signal so that the display will not be triggered and free run, quite independent of the signal's amplitude which may be much larger than the minimum.

Also in auto peak trigger mode the trigger level control is active. Its range will be automatically adjusted to coincide with the signal's peak-to-peak amplitude, hence the name. The trigger point will thus become almost independent of signal amplitude. This means that even if the signal is decreased the trigger will follow, the display will not loose trigger. As an example: the duty cycle of a square wave may change between 1:1 and 100:1 without losing the trigger.

Depending on the signal the LEVEL A/B control may have to be set to one of its extreme positions.

The simplicity of this mode recommends it for most uncomplicated signals. It is also preferable for unknown signals.

This trigger mode is independent of the trigger source and usable as well for internal as external triggering. But the signal must be > 20 Hz.

Normal trigger mode (See menu MODE)

Consult the chapters: MODE ⑳ > AUTO, LEVEL A/B ⑲, FILTER ㉑ and SOURCE ㉒ in "Controls and Readout". Information about how to trigger very difficult signals can be found in the HOR menu ㉓ where the functions time base fine adjustment VAR, HOLD-OFF time setting, and time base B operation are explained.

With normal triggering and suitable trigger level setting triggering may be chosen on any point of the signal slope. Here, the range of the trigger level control depends on the trigger signal amplitude. With signals < 1 cm care is necessary.

In normal mode triggering there will be no trace visible in the absence of a signal or when the signal is below the minimum trigger amplitude requirement!

Normal triggering will function even with complicated signals. If a mixture of signals is displayed triggering will require repetition of amplitudes to which the level can be set. This may require special care in adjustment.

Slope selection (Menu FILTER)

After entering FILTER ㉑ the trigger slope may be selected using the function keys. See also "Controls and Readout". AUTOSSET will not change the slope.

Positive or negative slope may be selected in auto or normal trigger modes. Also, a setting "both" may be selected which will cause a trigger irrespective of the polarity of the next slope.

Rising slope means that a signal comes from a negative potential and rises towards a positive one. This is independent

of the vertical position. A positive slope may exist also in the negative portion of a signal. This is valid in automatic and normal modes.

Trigger coupling (Menu: FILTER)

Consult chapters: MODE ⑳ > AUTO, LEVEL A/B ⑲, FILTER ㉑ and SOURCE ㉒ in "Controls and Readout". In AUTOSSET DC coupling will be used unless ac coupling was selected before. The frequency responses in the diverse trigger modes may be found in the specifications.

With internal DC coupling with or without LF filter use normal triggering and the level control. The trigger coupling selected will determine the frequency response of the trigger channel.

AC:

This is the standard mode. Below and above the fall-off of the frequency response more trigger signal will be necessary.

DC:

With direct coupling there is no lower frequency limit, so this is used with very slowly varying signals. Use normal triggering and the level control. This coupling is also indicated if the signal varies in its duty cycle.

HF:

A high pass is inserted in the trigger channel, thus blocking low frequency interference like flicker noise etc.

Noise Reject:

This trigger coupling mode or filter is a low pass suppressing high frequencies. This is useful in order to eliminate hf interference of low frequency signals. This filter may be used in combination with DC or ac coupling, in the latter case very low frequencies will also be attenuated.

LF:

This is also a low pass filter with a still lower cut-off frequency than above which also can be combined with DC or ac coupling. Selecting this filter may be more advantageous than using DC coupling in order to suppress noise producing jitter or double images. Above the pass band the necessary trigger signal will rise. Together with ac coupling there will also result a low frequency cut-off.

Video (tv triggering)

Selecting MODE > Video will activate the TV sync separator built-in. It separates the sync pulses from the picture content and enables thus stable triggering independent of the changing video content.

Composite video signals may be positive or negative. The sync pulses will only be properly extracted if the polarity is right. The definition of polarity is as follows: if the video is above the sync it is positive, otherwise it is negative. The polarity can be selected after selecting FILTER. If the polarity is wrong the display will be unstable resp. not triggered at all as triggering will then initiated by the video content. With internal triggering a minimum signal height of 5 mm is necessary.

The PAL sync signal consists of line and frame signals which differ in duration. Pulse duration is 5 μ s in 64 μ s intervals. Frame sync pulses consist of several pulses each 28 μ s repeating each half frame in 20 ms intervals.

Both sync pulses differ hence as well in duration as in their repetition intervals. Triggering is possible with both.

Frame sync pulse triggering

Remark:

Using frame sync triggering in dual trace chopped mode may result in interference, then the dual trace alternate mode should be chosen. It may also be necessary to turn the readout off.

In order to achieve frame sync pulse triggering call MODE, select video signal triggering and then FILTER to select frame triggering. It may be selected further whether "all", "only even" or "only odd" half frames shall trigger. Of course, the correct vt standard must be selected first of all (625/50 or 525/60).

The time base setting should be adapted, with 2 ms/cm a complete half frame will be displayed. Frame sync pulses consist of several pulses with a half line rep rate.

Line sync pulse triggering

In order to choose line sync triggering call MODE and select VIDEO, enter FILTER, make sure that the correct video standard is selected (625/50 or 525/60) and select Line.

If ALL was selected each line sync pulse will trigger. It is also possible to select a line number "LINE No."

In order to display single lines a time base setting of TIME/DIV. = 10 μ s/cm is recommended, this will show 1½ lines. In general the composite video signal contains a high DC component which can be removed by ac coupling, provided the picture is steady. Use the POSITION control to keep the display within the screen. If the video content changes like with a regular TV program only DC coupling is useful, otherwise the vertical position would continuously move.

The sync separator is also operative with external triggering. Consult the specifications for the permissible range of trigger voltage. The correct slope must be chosen as the external trigger may have a different polarity from the composite video. In case of doubt display the external trigger signal.

LINE trigger

Consult SOURCE ② in "Controls and Readout" for specific information.

If the readout shows Tr:Line the trigger signal will be internally taken from the line (50 or 60 Hz).

This trigger signal is independent of the scope input signals and is recommended for all signals synchronous with the line. Within limits this will also be true for multiples or fractions of the line frequency. As the trigger signal is taken off internally there is no minimum signal height on the screen for a stable display. Hence even very small voltages like ripple or line frequency interference can be measured.

Please note that with line triggering the polarity switching will select either the positive or negative half period of the line, not the slope. The trigger level control will move the trigger point over most of a half wave.

Line frequency interference may be checked using a search coil which preferably should have a high number of turns and a shielded cable. Insert a 100 Ω resistor between the center conductor and the BNC connector. If possible the coil should be shielded without creating a shorted winding.

Alternate trigger

This mode is selected with SOURCE ② > Alt. 1/2. The readout will display Tr:alt, but no more the trigger point symbol indicating level and time position. Instead an arrow pointing upwards will indicate the trigger time position if this lies within the screen area.

This trigger mode is to be used with greatest care and should be an exception rather than the rule, because the time relationships visible on the screen are completely meaningless, they depend only on the shape of the signals and the trigger level!

In this mode the trigger source will be switched together with the channel switching, so that when CH1 is displayed in the dual channel alternate mode the trigger is taken from CH1 and when CH2 is displayed the trigger is taken from CH2. This way two uncorrelated signals can be displayed together. If this mode is inadvertently chosen the time relationships between the signals will also be lost when both signals are correlated! (Except for the special case that both happen to be square waves with extremely fast rise times). Of course, this trigger mode is only possible in the dual channel alternate mode and also not with external or line trigger. Ac coupling is recommended for most cases.

External triggering

In analog mode this trigger mode may be selected with SOURCE ② > Extern. In DSO mode it is only possible if channels 3 and 4 are turned off. The readout will display Tr:ext. CH4 ④ will be the input for the external trigger, all internal sources will be disconnected. In this mode the trigger point symbol (level and time position) will not be displayed, only the trigger time position will be indicated. External triggering requires a signal of 0.3 to 3 V_{pp} , synchronous to the vertical input signal(s).

Triggering will also be possible within limits with multiples or fractions of the vertical input signal frequency. As the trigger signal may have any polarity it may happen that the vertical input signal will start with a negative slope in spite of having selected positive slope; slope selection refers now to the external trigger.

Indication of triggered operation (TRIG'D LED)

Refer item ③ in "Controls and Readout". The LED labelled TRIG'D indicates triggered operation provided:

- Sufficient amplitude of the internal or external trigger signal.
- The trigger point symbol is not above or below the signal.

If these conditions are met the trigger comparator will output triggers to start the time base and to turn on the trigger indication. The trigger indicator is helpful for setting the trigger up, especially with low frequency signals (use normal trigger) resp. very short pulses.

The trigger indication will store and display triggers for 100 ms. With signals of very low rep rate the indicator will flash accordingly. If more than one signal period is shown on the screen the indicator will flash each period.

Hold-off time adjustment

Consult "Controls and Readout" HOR ⑩ > Hold-off time for specific information.

After the time base deflected the trace from left to right the trace will be blanked so the retrace is invisible. The next sweep will, however, not immediately start. Time is required to perform internal switching, so the next start is delayed for the so called hold-off time, irrespective of the presence of triggers. The hold-off time can be extended from its minimum by a factor of 10:1. Manipulation of the hold-off time and thus of the time for a complete sweep period from start to start can be useful e.g. when data packets are to be displayed. It may seem that such signals can not be triggered. The reason is that the possible start of a new sweep does not coincide with the start of a data packet, it may start anywhere, even before a data packet. By varying the hold-off time a stable display will be achieved by setting it just so that the hold-off ends before the start of a data packet. This is also handy with burst signals or non-periodic pulse trains.

A signal may be corrupted by noise or hf interference so a double display will appear. Sometimes varying the trigger level can not prevent the double display but will only affect the apparent time relationship between two signals. Here the variable hold-off time will help to arrive at a single display.

Sometimes a double display will appear when a pulse signal contains pulses of slightly differing height requiring delicate trigger level adjustment. Also here increasing the hold-off time will help.

Whenever the hold-off time was increased it should reset to its minimum for other measurements, otherwise the brightness will suffer as the sweep rep rate will not be maximum. The following pictures demonstrate the function of the hold-off:

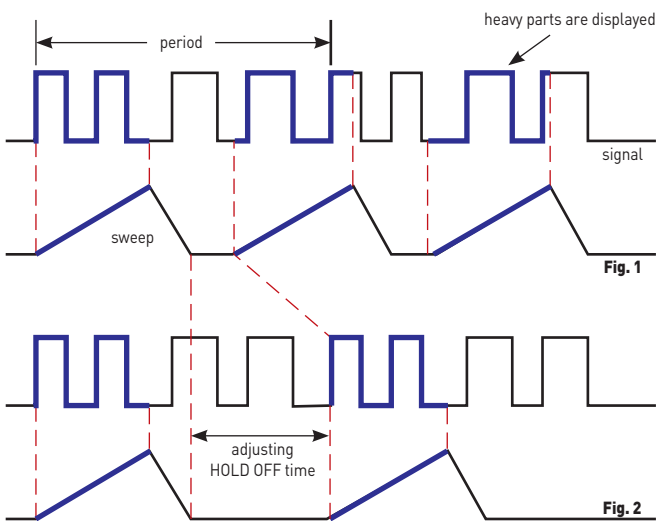

Fig. 1: Display with minimum hold-off time (basic setting). Double image, no stable display.

Fig. 2: By increasing the hold-off a stable display is achieved.

Time base B (2nd time base). Delaying, Delayed Sweep. Analog mode

Consult "Controls and Readout" HOR ⑩ and TIME/DIV. ⑫ for specific information.

As was described in "Triggering and time base" a trigger will start the time base. While waiting for a trigger – after runout of the hold-off time – the trace will remain blanked. A trigger will cause trace unblanking and the sweep ramp which deflects

the trace from left to right with the speed set with TIME/DIV. At the end of the sweep the trace will be blanked again and retrace to the start position. During a sweep the trace will also be deflected vertically by the input signal. In fact the input signal does continuously deflect the trace vertically, but this will be only visible during the unblanking time. This is, by the way, one marked difference to DSO operation where the input signal is only measured during the acquisition time, for most of the time the DSO will not see the signal. Also, in analog mode the signal itself will be seen on the screen in real time, whereas a DSO can only show a reconstruction of the signal acquired some time later.

In analog mode thus the display will always start on the left. Let us assume one period of a signal is displayed at a convenient time base setting. Increasing the sweep speed with TIME/DIV. will expand the display from the start, so that parts of the signal will disappear from the screen. It is thus possible to expand the beginning of the signal period and show fine detail, but it is impossible to show such fine detail for "later" parts of the signal.

The x10 Magnifier (MAG x10) may be used to expand the display and the horizontal positioning control can shift any part of the display into the centre, but the factor of 10 is fixed.

The solution requires a second time base, called time base B.

In this mode time base A is called the delaying sweep and time base B the delayed sweep. The signal is first displayed by TB A alone. Then TB B is also turned on which is the mode "A intensified by B". TB B should always be set to a higher sweep rate than A, thus its sweep duration will be also shorter than that of A. The TB A sweep sawtooth is compared to a voltage which can be varied such that TB A functions as a precision time delay generator. Depending on the amplitude of the comparison voltage a signal is generated anywhere between sweep start and end.

In one of two operating modes this signal will start TB B immediately. The TB A display will be intensified for the duration of TB B, so that one sees which portion of the signal is covered by TB B. By varying the comparison voltage the start of TB B can be moved over the whole signal as it is displayed by TB A. Then the mode is switched to TB B. The signal portion thus selected is now displayed by TB B. This is called "B delayed by A". Portions of the signal can thus be expanded enormously, however, the higher the speed of TB B the darker the display will become as the rep rate will remain that of the accepted signal triggers while the duration of TB B is reduced with increasing speed.

In cases where there is jitter the TB B can be switched to wait for a trigger rather than starting immediately. When a trigger arrives TB B will start on it. The jitter is removed, however, the effect is also, that the TB B start now can be only from signal period to signal period, no continuous adjustment is possible in this mode.

Alternate sweep

In this mode the signal is displayed twice, with both time bases. An artificial Y offset can be added in order to separate the two displays on the screen. The operation is analogous to Y dual trace alternate mode, i.e., the signal is alternately displayed by both time bases, not simultaneously which is not possible with a single gun crt. What was said above about how TB B can be started holds also here.

AUTOSET

For specific information consult "Controls and Readout" AUTOSET ⑩.

The following description is valid for both analog and DSO modes. AUTOSET does not change from analog to DSO mode or vice versa. If in DSO mode the modes "Roll", "Envelope" or "Average" (ACQUIRE) are present or the trigger mode „Single" (MODE) is selected, these modes will be switched off as AUTOSET always switches to "Refresh" acquisition. The signal to be displayed must meet the amplitude and frequency requirements of automatic triggering, to enable a useful automatic instrument setting.

All controls except for the POWER switch are electronically scanned, all functions can also be controlled by the microcomputer, i.e. also via the interfaces.

This is a precondition for AUTOSET as this function must be able to control all functions independent of control settings. AUTOSET will always switch to YT mode, but preserve the previous selection of CH1, CH2 or dual trace; ADD or XY modes will be switched to dual trace Yt.

Automatic setting of the vertical sensitivities and the time base will present a display within 6 cm height (4 cm per signal in dual trace) and about 2 signal periods. This is true for signals not differing too much from a 1:1 duty cycle. For signals containing several frequencies like video signals the display may be any.

Initiating the AUTOSET function will set the following operating conditions:

- last selection of ac or DC coupling
- internal triggering
- automatic triggering
- trigger level set to the center of its range
- calibrated Y sensitivities
- calibrated time base
- AC or DC trigger coupling unmodified
- HF trigger coupling switched to DC
- LF or Noise Reject filters left
- X magnifier switched off
- Y and X positioning automatic

Please note:

For pulse signals with duty cycles approaching 400:1 no automatic signal display will be possible.

In such cases switch to normal trigger mode and set the trigger position about 5 mm above the centre. If the trigger LED will then light up a trigger is generated and the time base is operating. In order to obtain a visible display it may be necessary to change the time base and V/DIV settings. Depending on the duty cycle and the frequency the signal may still remain invisible. This applies only to analog mode. In DSO mode the trace is always of equal brightness because not the signal is shown but a low frequency construction of it, also, there is no information in the trace intensity.

Component Tester

Specific information can be found in "Controls and Readout" under COMPONENT/PROBE ⑩ and COMPONENT TESTER ⑪.

The scope has a built-in component tester. The test object is connected with 4 mm banana plugs. In this mode the Y amplifiers and the time base are turned off. Only individual components may be tested, i.e. they must not be part of a circuit, if voltages are to be applied to the BNC connectors. If the components are part of a circuit this must be deenergized and disconnected from safety ground. Except for the two test leads there may be no further connection between scope and component. (See "Tests within a circuit"). As described in section "Safety" all ground connections of the scope are connected to safety ground including those of the component tester. As long as individual components are tested this is of no consequence.

The display can only be affected by the controls contained in the FOCUS/TRACE menu: A-Int., Focus, Trace rotation, HORIZONTAL position.

If components are to be tested which are parts of a circuit or an instrument those circuits resp. instruments must first be deenergized. If they are connected to the mains they must be unplugged. This will prevent a connection between scope and circuit via the safety ground which may affect the measurement.



Do not test charged capacitors.

The principle of the test is very simple: a sine wave generator within the scope generates a 50 Hz $\pm 10\%$ voltage which is applied to a series connection of the test object and a resistor within the scope. The sine wave proper deflects in X direction, the voltage across the resistor which is proportional to the test current deflects in Y direction.

If the object contains neither capacitors nor inductors, there will be no phase shift between voltage and current, so a straight line will show up which will be more or less slanted, depending on the value of the object's resistance, covering approx. 20 Ω to 4.7 k Ω . If there is a short the trace will be vertical, i.e. (almost) no voltage produces already high current. A horizontal line will thus indicate an open, there is only voltage but no current.

Capacitors or inductors will create ellipses. The impedance may be calculated from the ellipse's geometric dimensions. Capacitors of appr. 0.1 μF to 1000 μF will be indicated.

- An ellipse with its longer axis horizontal indicates a high impedance (low capacitance or high inductance)
- An ellipse with its longer axis vertical will indicate a low impedance (high capacitance or low inductance)
- A slanted ellipse will indicate a lossy capacitor or inductor.

Semiconductors will show their diode characteristics, however, only 20 V_{pp} are available, so the forward and reverse characteristics can only be displayed up to 10 Vp in each direction. The test is a two-terminal test, hence it is not possible to measure e.g. the current gain of a transistor. One can only test B-C, B-E, and C-E. The test current is only a few mA, so the test will not harm ordinary semiconductors. (Sensitive devices like delicate hf transistors etc. should not be tested). The limitation to 10

V_p with bipolar transistors will suffice mostly as usual defects will show up.

The best method to verify whether a component is defective is the comparison to a good one. If the lettering of a component is not legible at least it is possible to see whether it is a npn or pnp transistor or which end of a diode is the cathode.

Please note that reversing the test leads will also invert the picture, i.e. turn it 180 degrees.

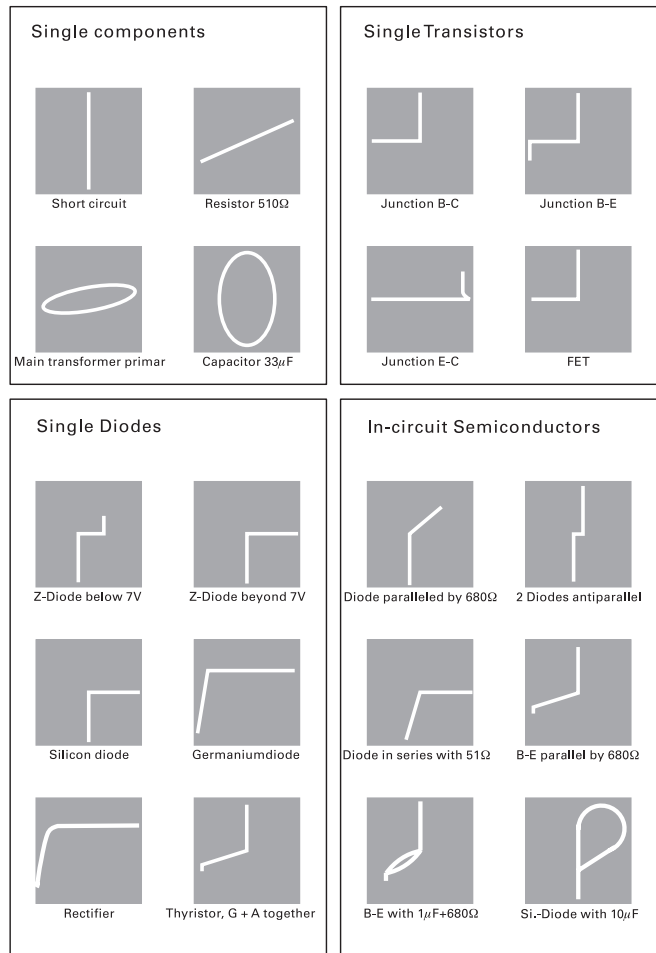
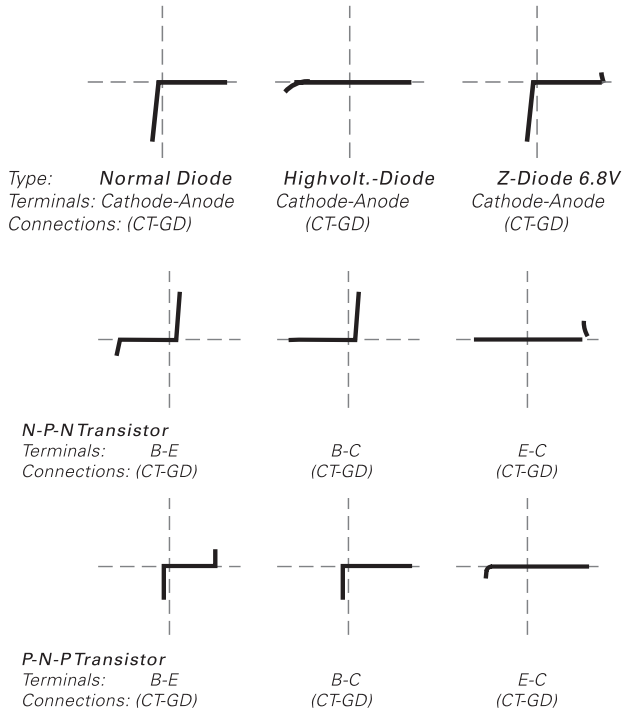

In most cases, e.g. with service and repair, it will be sufficient to receive a good/bad result (open, short). With MOS components the usual precautions are to be observed, but note, that except for a possible short MOSFETs and JFETs can not be sufficiently tested. Indications to be expected depend strongly on the kind of FET:

- With depletion type MOSFETs and all JFETs the channel will conduct if prior to testing the gate was connected to the source. The R_{dson} will be shown. As this can be very low it may look like a plain short although the part is good!
- With enhancement type MOSFETs an open will be seen in all directions, as the threshold voltage $G - S$ is not available. With power MOSFETs the antiparallel diode $S - D$ can be seen.

Tests of components within circuits are possible in many cases but less indicative because other components may be in parallel. But also here the comparison with a good circuit might help. As both circuits must be deenergized it is only necessary to switch the test leads back and forth between both in order to localize a defective spot. Sometimes like with stereo amplifiers, push-pull circuits, bridge circuits there is a comparison circuit right on the same board. In cases of doubt one component lead can be unsoldered, the other one should then be connected to the ground lead. This is labelled with a ground symbol. The pictures show some practical examples:

CombiScope®

HAMEG oscilloscopes are either analog or they are CombiScopes, i.e. they contain a complete analog scope and the additional hardware and software so sample and digitize the signals. The HM1508 is a 150 MHz 1 GS/s CombiScope®.

With a HAMEG CombiScope® the user is always sure: he needs only to switch from DSO to analog in order to see the true signal. This is especially important when a signal is to be documented in DSO mode. The user of a pure DSO needs to know the signal better than the scope!

The advantages of DSO operation are:

- Capture and storage of single events
- There will be no flicker with very low frequency signals
- Fast signals with a low rep rate resp. low duty cycle can be displayed at high intensity
- Due to the storage of all signals they may be easily documented and processed.
- Due to the down conversion of high frequencies into the kHz-area the very expensive analog crts are replaced by cheap computer monitor tubes or lcd displays. Also, the bulk part of the components may be the same as used in computers, thus inexpensive.

The disadvantages of DSO operation are:

- An analog scope displays the signal itself in real time. In a DSO the signal is not displayed but only a low frequency reconstruction of the signal. The limitations and problems of sampling operation as well as those of analog/digital conversion hold. The display can not be in real time as, after capturing a signal, the DSO must take time out to perform calculations the result of which will then be displayed much later.
- Therefore the capture rate of ordinary DSOs is orders of magnitude lower than that of any analog scope. Hence a DSO is least suited to catch rare events.
- There is no information in the trace, the trace is always of equal intensity. Thus valuable information (so called Z – axis) is lost. Also the fast slopes of a pulse which are invisible on an analog scope will be of the same intensity as the slower parts of the signal, this is a gross misrepresentation. The reason is that DSOs ordinarily do not show only the sampled points but they interpolate by drawing a continuous trace.
- The vertical resolution is mostly only 8 bits. In an analog scope there is no loss of fine detail by digitizing. Even if the trace is not very crisp details can be seen in it.
- Due to the sampling and the lack of a low pass filter in the input frequencies above half the sampling frequency will cause so called aliases, i.e. low frequency ghost signals. Sampling is practically the same as frequency conversion resp. multiplication, it creates sum and difference frequencies, beat frequencies which may be orders of magnitude lower than the signal frequency and give grossly erroneous results. In practice, therefore, only frequencies 1/10 or less of the sampling frequency can be reliably displayed. The meaning of the Nyquist theorem is mostly misunderstood:

if the sampling frequency is only twice the signal frequency there will only two points be displayed on the screen: any number of signal shapes may be drawn which fit through these two points. The Nyquist theorem contains a hidden knowledge that the signal is a sine wave. It is easily understood that, in order to depict an unknown signal shape one needs at least 1 or 2 points per centimeter; in other words: the useful signal frequency is only 1/10 to 1/20 at best.

- An analog scope has a frequency response which follows closely the Gaussian curve, this means in practice that also frequencies far beyond the -3 dB frequency will be shown, reduced in amplitude, but they will be shown. This not only preserves fine detail of a signal but it allows also to see, e.g., very high frequency wild oscillations in a circuit. This is not the case after sampling because all frequencies beyond half the sampling frequency will be „folded“ back into the lower frequency band.
- Due to limited memory depth the maximum sampling rate must be reduced with each DSO when the time base is set to slow sweep speeds, it may be reduced from GS/s to KS/s! Most users are not aware of this trap, they think that if they bought a DSO with 100MHz bandwidth and 1GS/s they are safe when measuring kHz-signals. But such low frequency signals will be distorted and aliases displayed.

Please note: This list of disadvantages is by far incomplete! It scratches but the surface.

There are 3 methods of sampling:

1. Real time sampling:

Here the Nyquist theorem must be observed, but, as mentioned, in practice the signal frequency is far less than 1/10 the sampling frequency. Consequently, with a 1GS/s rate signals with up to 100 MHz can be adequately reconstructed. Obviously, this is the only mode for single event capturing.

2. Equivalent time sampling:

This is the normal operating mode for all sampling scopes. (Sampling scopes are very old, they are still the fastest scopes with bandwidths > 50 GHz because they have no input amplifier. Sampling scopes are far superior to DSOs because their Y resolution is identical to that of an analog scope). In this mode consecutive periods of the signal are sampled, each period contributes but one sample. The signal period is thus scanned and very many periods are necessary in order to achieve one full screen display. This way a very high „effective“ sampling rate is achieved, this method exchanges bandwidth for time. In a sampling scope a very accurate display is created which is, as far as the shape is concerned, almost as good as that of an analog scope. In a DSO, however, the sample points are 8 bit a/d converted, losing resolution. The bandwidth achieved is given alone by the hf properties of the input and the minimum realizable duration of the sampling pulse, so 14 GHz at a sensitivity of 2 mV/cm and 50Ω were standard in the 60s. In a DSO, however, which should be used like an analog scope, a high impedance (1 MΩ) wide range (e.g. 1 mV/cm to 20 V/cm) attenuator must be included and also an input amplifier. This is why a DSO can not reach the bandwidths of sampling scopes. Equivalent time sampling suffers fully from the problems of aliasing. As it requires the (not necessarily periodic) repetition of the signal in invariant shape for e.g. millions of periods it is unsuitable for the capture of single events. Equivalent time sampling can not display the rising portion of a signal without a delay line.

3. Random sampling:

Random sampling is also very old (1952) and also no invention of DSOs. It is similar to equivalent time sampling in that it requires a multitude of signal repetitions with invariant shape in order to reconstruct it once on the screen. Therefore also in this mode a very high „effective“ sampling rate is achieved. However, the samples are not taken step for step along the signal but randomly distributed over the signal period. An analog computer is used to estimate the arrival of the next trigger, and the time base is already started when it arrives. This has two enormous advantages:

1st The rising portion of the signal can be shown without the need for a delay line which would severely limit the achievable bandwidth.

2nd Due to the randomness of the samples alias signals will be broken up.

The foregoing explains why it is HAMEG policy to offer Combiscopes rather than pure DSOs which combine the best of both worlds although the cost of such an instrument is markedly higher than that of a pure DSO, take alone the complicated high frequency crt. It is the low cost of manufacturing which causes the drive towards DSOs.

DSO Operation

The 150 MHz scope has 2 8 bit a/d converters of the flash type which is the best there is. The maximum sample rate of each is 500 MS/s which is the rate available in dual channel mode for the capture of single events. The maximum sampling rate in all other operating modes is 1 GS/s.

Higher effective (!) sampling rates are possible as explained above in equivalent and random sampling modes. As very many signals repetitions are needed to reconstruct the signal once any changes in signal shape such as noise will show up.

The reconstructed signal may be displayed either by showing only the sampled points or with interpolation between them by drawing straight lines.

The signals stored in DSO mode can be read via an interface and documented. See the chapter "Data Transfer" for details.

DSO operating modes

In DSO mode the following operating modes are available:

1. Menu: ACQUIRE: Repetitive triggered signal acquisition and display in usual Yt representation.

REFRESH: readout shows "rfr" (real time sampling) or Random sampling: readout "RS:xGSa".

The operating mode may be further subdivided:

Envelope: readout "env"
Average: readout "avg:x"
(x may be a number 2.. 512)

2. ROLL mode, untriggered continuous signal acquisition, display will „roll“ over the screen from left to right in usual Yt mode:

Roll: readout "rol"

3. Single sweep, triggered (menu: Trigger MODE) signal capture in usual Yt mode:

Single: readout "sgl"

4. Untriggered continuous signal capture, display in XY mode (Menu: trigger MODE):

XY: readout "XY"

5. XY display of signals which were previously captured in Yt mode and protected against overwriting by STOP:

XY: readout "XY"

Signal capture is triggered in SINGLE, REFRESH, ENVELOPE, and AVERAGE modes and untriggered in ROLL and XY modes.

The normal (Refresh) mode is similar to the operating mode of an analog scope. Triggering will cause signal acquisition and display from left to right. After the next acquisition the display will be replaced by the new information. If automatic triggering was selected there will be a reference trace in the absence of a signal the position of which is dependent on the vertical position control setting. Signals with a repetition rate lower than the rep rate of the automatic triggering can not properly trigger so the resulting display will be untriggered.

In contrast to an analog scope the last display will remain on the screen if the signal disappears in normal trigger mode.

In SINGLE mode the signal will be acquired only once. Acquisition can start if STOP (RUN key) is not illuminated (if necessary press RUN until STOP extinguishes). The next trigger received will cause the single acquisition. After this STOP will light up and the trigger mode will be automatically switched to normal DC coupled if auto was selected.

The trigger symbol on the screen allows to directly see resp. determine the voltage level desired for triggering in the normal mode, the voltage follows from the position and the VOLTS/cm selected. The ground reference will be indicated by a ground symbol in the screen centre.

After selecting SINGLE the trigger level symbol may be positioned using the LEVEL control. If e.g. the symbol is 2 cm above the ground reference symbol the trigger level will be 2 cm x Volts/cm (x probe factor if any).

Example: 2 cm x 1 V/cm x 10 (probe) = + 20 V.

Memory resolution

Vertical resolution:

The 8 bit a/d converters have a resolution of 256 possible vertical positions. The screen display has a resolution of 25 points per cm. This is advantageous for display, documentation and post-processing.

There may be some difference between the display on screen and documentation, e.g. on a printer, this results from various tolerances in the analog circuitry involved. The trace positions are defined by:

Median horizontal line:	10000000b	80h	128d
Top line:	11100100b	E4h	228d
Bottom line:	00011100b	1Ch	28d

In contrast to an analog display with its theoretically infinite resolution this is limited to 25 points per cm in DSO mode. If there is any noise superimposed on the signal this may cause frequent change of the lowest bit and thus jumping of the trace in vertical direction.

Horizontal resolution:

A maximum of 4 simultaneous signal displays may be shown on the screen. Each signal display will consist of 2048 points (bytes). 2000 points will be distributed over 10 cm. The resolution is thus 200 points per cm. Please note that this a 4 to 8 times

improvement over customary VGA (50 points per div) or LCD (25 points per div.) DSO displays.

Memory depth

1 GS/s means that one million samples will be taken of the signal and stored. With normal triggering and time base settings of >20 ms/cm there will be 500,000 samples.

The screen display is calculated from the whole memory contents. Within the menu Settings->Display several display modes may be selected:

- Dots: the sampling points only are displayed.
- Vectors: interpolation (sin x/x) or dot join is used to generate a continuous trace.
- Optimal: In this mode all samples are used to calculate the display. This way the display of aliases is less likely.

The scope acquires with as high a sampling rate as is possible thus preventing to a large extent the production of alias signals. It is always possible to zoom through the memory in order to look at details, and, thanks to the deep memory, signal details may be shown which remain invisible with shorter memory DSOs.

Example:

This scope will sample with 1 GS/s in single channel mode down to a time base setting of 100 us/cm. This equals 100,000 points per cm. In MEMORY ZOOM signals of 150 MHz can still be seen. Down to 100 us/cm hence aliases are not to be expected due to the bandwidth limit of 150 MHz and the critical frequency being > 500 MHz.

DSOs with a shorter memory like e.g. 10 K will only present 1000 points per cm which is equivalent to a sampling rate of 10 MHz, thus signals > 5 MHz will cause aliases, far below the scope bandwidth. A deep memory is one of the most important criterion of a DSO.

Horizontal resolution with X magnifier

In principle, with a 10 x magnified sweep, the resolution should be reduced to 20 points per cm. However, the resolution remains at 200 points per cm as the information necessary will be calculated from the memory. The magnified portion may be selected with the X-POS control. The fastest time base will be 5 ns/cm allowing a 2 cm per period display of 100 MHz.

Maximum signal frequency in DSO mode

The highest signal repetition frequency which still can be displayed well can not be exactly given. This is dependent as well on the signal shape as on its amplitude displayed.

While it is fairly easy to recognize a square wave it requires at least 10 samples per period to distinguish a sine wave from a triangle. In other words: in practice, signals may still be recognized if their repetition frequency is <1/10 of the sampling frequency. For a well defined display, however, many more than 10 points per cm are necessary.

Display of aliases

As explained the maximum sampling rate must be reduced for slow time base settings. This may cause aliases. If e.g. a sine wave is sampled only with one sample per period and if it should be synchronous with the sampling frequency a horizontal line

will be shown as each time the same signal point is sampled. An alias may also take the form of a signal of much lower frequency (beat frequency between signal and sampling frequencies), apparently untriggered changing displays, or may look like AM modulated signals. If an alias is suspected change the signal frequency or the time base or both. If aliases remain undetected grossly erroneous results will be obtained which includes also grossly (maybe orders of magnitude) false displays of signal parameters like rise time etc.! Always watch for a stepped display or print-out: this indicates an insufficient sampling rate and consequently a false display. With an insufficient sampling rate e.g. fast, short pulses may be completely ignored.

The best method to detect any false DSO display is to switch to analog mode. In analog mode false displays are absolutely impossible! An analog scope can at worst round the edges of very fast signals.

Vertical amplifier operating modes

In principle, in DSO mode there are the same modes available as in analog mode, i.e.:

- CH1 only
- CH2 only
- CH1 and CH2 in dual trace mode Yt or XY
- Sum
- Difference

The main differences of DSO mode are:

- In dual channel mode both channels resp. signals are a/d converted simultaneously.
No alternate or chopped channel switching.
- No flickering display even with low frequency signals as the signals are stored and continuously displayed from the memory with a sufficiently high rep rate.
- Trace intensity is always the same. This is an advantage and a disadvantage.

All so called Z axis (trace intensity) information is lost. In analog mode the intensity depends on the signal rep rate resp. the speed, thus mixed or unstable signals can be differentiated by their respective trace intensity. Fast slopes of low frequency signals are invisible in analog mode, in DSO mode they will be shown as bright as the other signal portions.

Data transfer

Please note: Interface modules may only be exchanged after the instrument was turned off. During operation the opening of the interface must be covered.

There is an opening on the rear panel into which various interface modules can be inserted. Instruments are delivered with RS-232 installed. (H0710)

The interface allows to either remotely control the scope or read its settings. In DSO mode also the digitized and stored signals may be retrieved. Interface cables must be shielded and must not reach a length of 3 m or more.

H0710: RS232 Interface. Remote control

**Safety hint:**

All interface connections are galvanically connected to the scope.

Measurements at high potentials are prohibited and endanger the scope, the interface and all gear connected to the interface.

If the safety rules are disregarded any damage to HAMEG products will void the warranty. Neither will HAMEG take any responsibility for damages to people or gear of other make.

Description:

The RS232 interface on the rear panel has the usual 9 pole SubD connector. Via this bidirectional interface the scope can be controlled remotely or its settings may be transferred. In DSO mode also the digitized and stored signals can be read out. The connection to a pc requires a 9 pole screened cable (1:1) of 3 m maximum length. The pinout is as follows:

Pin**no. Function**

- 2 Tx data from scope to external device
- 3 Rx data from external device to scope
- 7 CTS ready to transmit
- 8 RTS ready to receive
- 5 ground (scope is connected to safety ground, safety class I)
- 9 + 5 V, max. 400 mA

The maximum signal on Tx, Rx, RTS and CTS is ± 12 V. The RS-232 interface parameters are:
N-8-2 no parity, 8 bits data, 2 stop bits (RTS/CTS hardware protocol)

Selection of Baud rate

Baud rate setting is automatic. Range: 110 to 115200, no parity, 8 bits data, 2 stop bits.

The first SPACE CR (20 hex, 0D hex) character sent after POWER UP will set the Baud rate. This will remain set until POWER DOWN or until a RM=0 command was sent. If activated previously also the front panel LOCAL (auto range) key may be used. After release of remote (REM key ) data transfer can only be reinitiated if a SPACE CR character was sent..

If the scope can not recognize a SPACE CR as the first character TxD will be pulled low after 0.2 ms which causes a frame error.

If the scope did recognize a SPACE CR und adjusted its Baud rate accordingly it will answer with RETURN CODE "O CR LF". The front panel controls will be deactivated. The time between Remote Off and Remote ON must be greater than:
 $t_{min} = 2 \times (1/\text{Baud rate}) + 60 \text{ us}$.

Data transmission

After a successful Baud rate recognition and setting the scope will be in the remote control mode and waits for commands. In this mode no manual operation is possible. In order to return to manual control a command must be sent from the PC or the REMOTE OFF key depressed.

Loading of new firmware

Under www.hameg.de the most recent firmware is available for downloading.

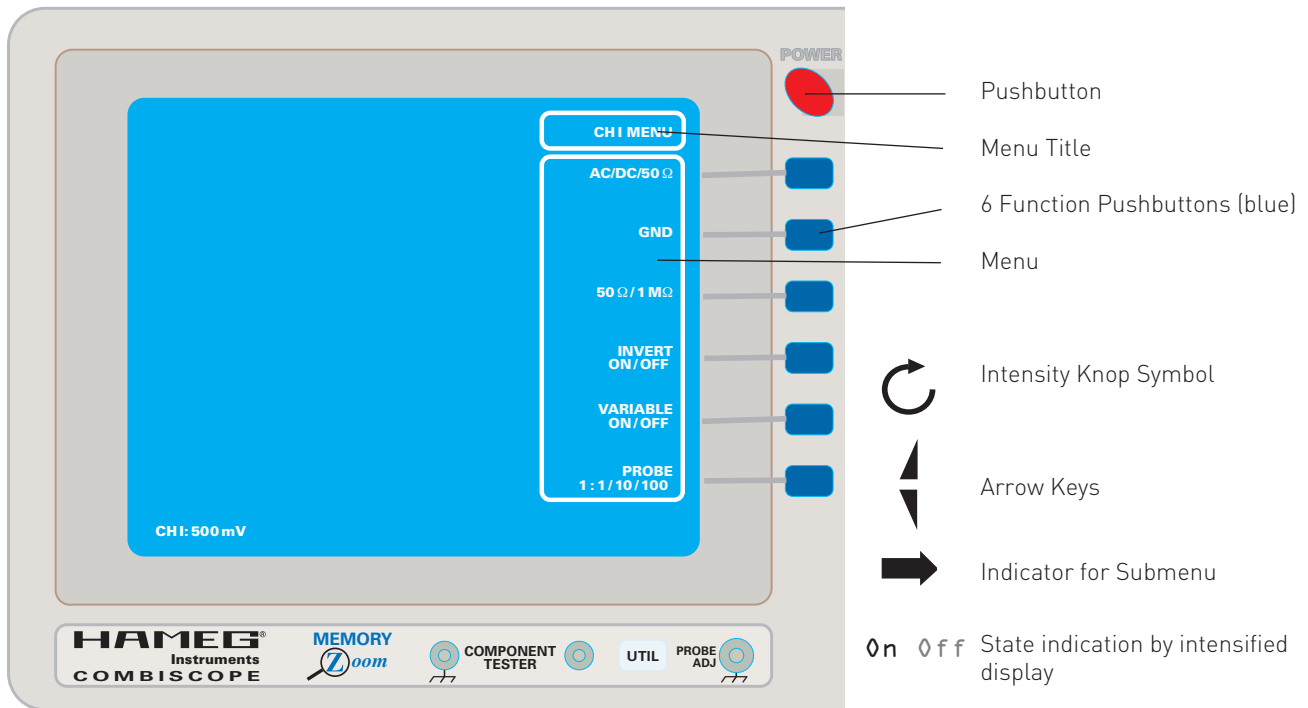

General information concerning MENU

Menu and HELP displays

Whenever a pushbutton is depressed the corresponding menu will be displayed except for: EXIT MENU/REMOTE OFF ④, ANALOG – DIGITAL ⑤, AUTOSET ⑩, RUN – STOP ⑥ and MAG x10 ⑳. The menus offer options which may then be selected with the blue pushbuttons. All pushbuttons are on/off.

Exiting a menu:

- 1st The user may set a time after which the menu will be left. (SETTINGS ⑩ pushbutton >, Misc > Menu OFF.
- 2nd Before the time set as described has elapsed a menu can be exited by pressing EXIT MENU.
- 3rd Only manually if the function "Man" was selected ③.
- 4th Pressing the same pushbutton again.
- 5th Pressing another pushbutton.

If a menu shows a knob symbol ② this pertains to the INTENS knob ②. It allows to change settings. Also arrows may be shown which point to available submenus.

In some modes some pushbuttons or knob operations are meaningless and will hence not cause a menu display.

Please note:
If a menu is shown some other information displayed in the readout may disappear, this will reappear immediately upon leaving the menu.

Each menu is assisted by HELP texts, which can be called by pressing the HELP ⑫ and which will be also displayed by the readout. If HELP was called and the INTENS knob ② moved an

explanation of the actual INTENS knob ② function will be given. HELP will be left by pressing the pushbutton again.

Please note:
During the display of help texts and menus in full size no signal display is possible.

Remarks

In operation all relevant measuring parameters will be shown in the readout, provided the readout was activated and its intensity is sufficient.

The front panel LEDs add to the operating comfort and give more information. In the end positions of the control knob an acoustical signal will sound.

Apart from the POWER ① pushbutton all control elements are scanned and stored. This allows to control the instrument from stored information. Some controls and menus are only operative in DSO mode or change their meaning in this mode. Explanations are given with the warning: "Only in DSO mode."

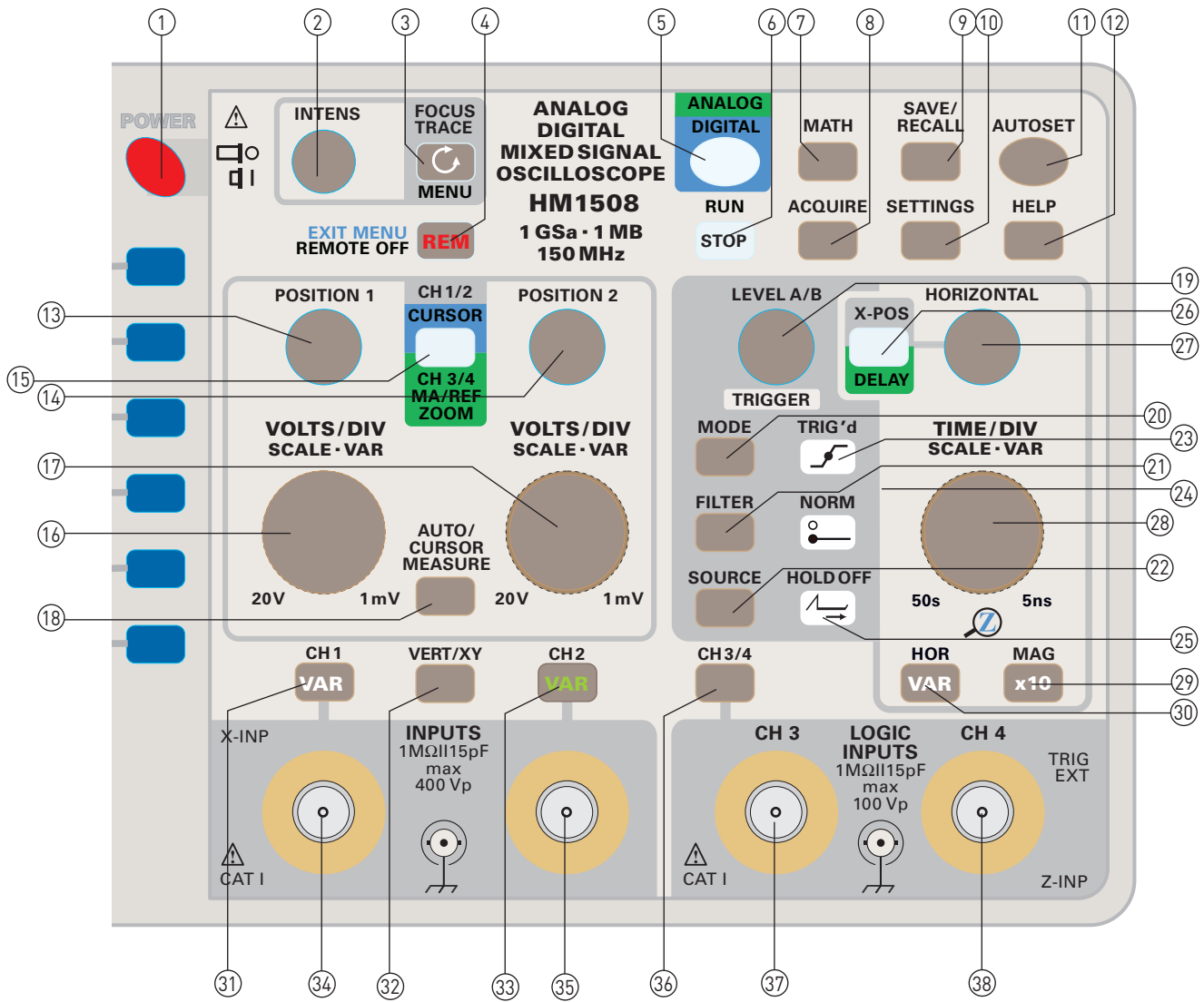

Controls and Readout

① POWER

Mains switch with symbols I = ON and O = OFF.

After turning the scope on and after the warm-up time of the crt heater has elapsed the HAMEG logo, the instrument type and the version number are displayed. If prior to switching off the function "Quick Start" was selected [SETTINGS ⑩ > Misc] the above will not be displayed. Then the scope will assume the settings which existed before switching off.

② INTENS knob C

This knob controls various functions:

2.1 Trace intensity if the FOCUS/TRACE/MENU ③ pushbutton does not light the knob symbol C. Turn left for decreasing and right for increasing.

2.2 If the knob symbol XXX of the pushbutton ③ is illuminated the control will act for those functions displayed in the menu, which were activated.

③ FOCUS TRACE MENU

If the knob symbol C will light after pressing this pushbutton the Int.Knob menu will be shown.

Depending on the operating mode the menu contains:

A-Int.: Intensity of the signal as displayed by time base A

B-Int.: Intensity of the signal as displayed by time base B (analog mode only)

Zoom Int. Intensity of the signal as displayed by ZOOM (digital mode only)

RO-Int.: Readout intensity

Focus: Focus for signal and readout

Readout

On Off: Turning the readout off will eliminate interference of the readout with the signal(s). The knob symbol will blink as long as the readout is off. Only menus and help texts will be shown.

Trace rotation: Trace rotation (see TR)

After turn-on the readout will always be on.

④ EXIT MENU/REMOTE OFF (REM)

This pushbutton has two functions:

4.1 If a menu is displayed pressing this pushbutton will turn it off. On condition a submenu is displayed, pressing this pushbutton switches back to the menu.

4.2 Under remote control this pushbutton will be illuminated. After pressing the pushbutton, control is returned to the front panel.

⑤ **ANALOG/DIGITAL**

Switches between analog (green) and DSO modes (blue). The operating mode (Yt or XY) will not be affected. If component test mode was selected, possible only in analog mode, and the scope is switched to digital the operating mode last used when in DSO mode will be reinstalled.

Y parameters will not be changed by the switching. Time base modes will be changed due to the different operation of the time bases in both modes. After any switching time base A will be selected. The time base speeds selected will not be affected unless they are not available any more, then the maximum value will be chosen.

⑥ **RUN/STOP**

This pushbutton has several functions:

6.1 **Analog mode, single sweep**

The RUN/STOP pushbutton is used to set the time base for a single sweep. Press MODE ⑳ and activate "Single" in this menu. By pressing RUN/STOP the scope will wait for the next trigger indicated by STOP blinking. After a signal triggered the time base and the sweep is over the scope will stop, indicated by STOP continuously illuminated. Each time the pushbutton is depressed the scope will be activated anew for one trigger resp. one sweep.

6.2 **DSO mode, single capture**

In order to prepare the scope for a single capture press MODE ⑳ and select "Single" in the menu presented. By pressing RUN/STOP the scope will start to continuously acquire and store so that later also the signal preceding the occurrence of the trigger (Pre-trigger) will be available. STOP will blink in order to signal that as yet no trigger was recognized. Upon receipt of a trigger the acquisition will be completed so the signal following the trigger (Post-trigger) will later be available, too. STOP will then remain illuminated. The signal display on the screen will be frozen. Pressing RUN/STOP again will prepare for another acquisition as described. Each new acquisition will overwrite the preceding one.

In order to leave this mode enter the MODE menu and select "Auto" or "Normal".

6.2.1 **DSO mode, ending or interrupting a capture.**

Any capture in progress may be stopped by pressing RUN/STOP.

6.2.2 **DSO mode, reset function.**

Pressing RUN/STOP twice in "env" (Envelope) or "avg" (Average) mode, where the signal display is the result of more than one signal data acquisition, causes the previous signal capture results to be deleted and a new start of the signal capture.

⑦ **MATH**

Only available in DSO mode.

This pushbutton calls the "Mathematics" menu and the "Formula editor". With the "Mathematics" menu stored signals may be mathematically processed, either directly or with reference to other stored signals. The results may be graphically displayed on the screen and determined by the cursor functions. All

entries and settings will be automatically stored upon leaving the Mathematics menu or turning the scope off. Measurement results will be lost after turn-off.

"Mathematics" offers:

7.1 **Equations set**

Using the INTENS knob ㉔ 5 sets of formulas can be selected for editing. This way 5 user-defined formula sets may be created.

Each set of formulas consists of 5 lines with one equation each, designated MA1 to MA5. An equation may occupy one or more lines. In this case it has to be kept in mind that the lines of equations are processed as a stack, i.e. starting with MA1 = 1st line to MA5 = 5th line.



Please note:

That formula set is valid which is shown prior to leaving the MATH menu.

7.2 **Edit**

"Edit" opens the "Mathematics Edit" submenu.

7.2.1 **Equation**

5 equations may be selected with the INTENS knob ㉔. Each equation consists of the name of a result (e.g. MA5), the = sign, the function (e.g. ADD) and (first operand, second operand). Remark: The second operand will not be displayed with all functions.

7.2.2 **Function**

By using the INTENS knob ㉔, the following functions may be selected:

- ADD:** Operand 1 + operand 2
- SUB:** Operand 1 – operand 2
- MUL:** Operand 1 times operand 2.
- DIV:** Operand 1 divided by operand 2.
- SQ:** Operand 1 squared.
- INV:** Changes sign of operand 1.
- 1/:** Calculates 1/operand 1 (reciprocal value).
- ABS:** Takes absolute value of operand 1 (removes sign)
- POS:** Only values of operand 1 > 0 are displayed, < 0 will not be displayed.
- NEG:** Only values of operand 1 < 0 are displayed, > 0 will not be displayed.

7.2.3 **Operand 1**

The INTENS knob ㉔ allows the selection of these signals as operands:

- CH1:** CH1 signal.
- CH2:** CH2 signal.
- RE1:** Signal from reference memory 1
- RE2:** Signal from reference memory 2
- MA1:** Result of equation named MA1.
- MA2:** Result of equation named MA2
- MA3:** Result of equation named MA3.
- MA4:** Result of equation named MA4
- MA5:** Result of equation named MA5.

The next step after MA5 causes the display "Edit". Calling "Edit" opens a sub submenu described under item 7.2.5.

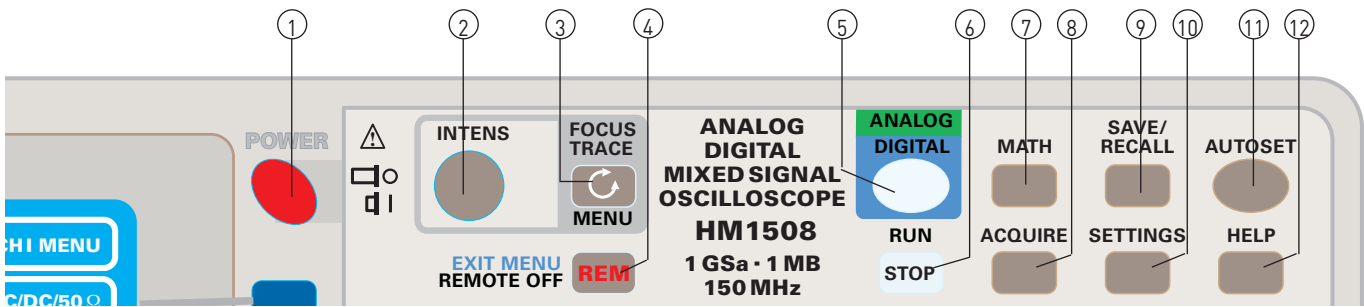

7.2.4 **Operand 2:**

The INTENS knob ㉔ allows the selection of the same operands as mentioned under item 7.2.3 (Operand 1) if ADD, SUB, MUL or DIV function is chosen.



The next step after "MA5" causes the display "Edit". Calling "Edit" opens a sub submenu described under item 7.2.5.

7.2.5 Edit > Constant Edit

In the CW position of the INTENS knob  an additional item "Edit" and an arrow symbol is displayed. Pressing the associated function button opens the sub submenu "Constant Edit". This enables to choose a Number, its "Dec.Point" (decimal point) and its "Prefix" of the "Unit", all with the INTENS knob . The unit need not be selected it is only shown to assist the memory.

7.3 Display



Attention!

Switching from "Display Off" to "Display MA1 MA5" is not possible if channel 3 and 4 are switched on. The display of mathematic signal(s) automatically switches previously displayed reference signals off and vice versa.

The function "Display" is available twice in the menu and may be switched on or off in any combination. This allows to display: no result, one result, the result of two equations as signals. The displays will come forward upon leaving the "Mathematics" menu. Also the designation of the equation (e.g. MA2) will be shown. Select the equations to be displayed with the INTENS knob .

The mathematics signal is automatically scaled, this is independent of the graticule, of Y and time base parameters, the scale will not be shown. Hence the measurement of the signal amplitudes must be performed using the CURSOR (V to GND) after the "reference" (e.g. MA2) of the CURSOR to the "mathematics signal" and its scale was established (AUTO/CURSOR MEASURE  pushbutton > Cursors > reference > e.g. MA2). The readout may then display e.g.: "V(MA2): 900 mV".

Divisions by zero will be ignored and an error message displayed.

7.4 Units

Each function "Display" will be associated with a function "Unit" which can be selected with INTENS  and will be attached to the result.

⑧ Acquire

Available only in DSO mode.

This pushbutton opens the menu ACQUIRE which offers these modes:

8.1 Refresh capture/display.

In this mode repetitive signals may be captured and displayed much like in analog mode. The readout will show "rfr". Signal

acquisition may be stopped or started with the RUN/STOP pushbutton. The STOP pushbutton will be illuminated in stop.

A trigger will start a new acquisition which will overwrite the display of the former. The display will remain on screen until the next acquisition. This mode is available over the full time base range (50 s/cm to 5 ns/cm).



Please note:

After changing the time base acquisition and display will always start first at the trigger position which is undelayed (Readout: "Tt:0s") on the screen centre. With the 2nd acquisition the display will start at the screen left. In most cases this is meaningless, but the scope may seem not to react at slow time base settings combined with long Posttrigger times.

In the utmost left position of the trigger point selected with the HORIZONTAL control  the readout will indicate "Tt:1.85ks" for a time base setting of 50 s/cm. This means that 1,600 seconds must elapse until the trace will become visible at the screen left, after another 250 s it will have reached the screen centre (1,600 s + 250 s = 1.85 ks).

8.2 Envelope capture/display

Envelope is a special mode in refresh mode, the readout will show "env". Also in this mode there must be sufficient signal for triggering.

In contrast to the refresh mode the results of several captures will be examined and the maxima and minima stored, the envelope of the signal will then be displayed if it changes in amplitude or/and frequency. Also any jitter will be shown.

Also in this mode pressing RUN/STOP  will stop the acquisition, indicated by STOP illuminated. After pressing the pushbutton again the formerly stored signals will be erased and the envelope calculation starts anew. In order to prevent an accidental turning on of this mode operating any control which influences the signal display will automatically switch envelope off.

Because this mode requires many signal repetitions and acquisitions it is not compatible with single sweep/acquisition. AUTO or normal trigger modes must be selected.

8.3 Average mode capture/display

Also this is a special mode within the refresh mode. Also here signal repetitions are needed.

The weighting of each acquisition can be selected with "Average" in the menu, any number between 2 and 512 may be chosen using the INTENS knob . The readout will show e.g. "avg#512".

The higher the number of acquisitions averaged the lower the contribution of a single acquisition will be and the longer the averaging will take. Averaging is a means to increase the accuracy in spite of the 8 bit converters, it is an exchange of time against accuracy. Noise will be reduced by averaging.

The same holds as for envelope: the acquisition may be stopped by pressing the RUN/STOP pushbutton, STOP will be illuminated. Pressing RUN/STOP again will restart. In order to prevent an inadvertent entering of this mode the operation of any control will automatically cause this mode to be reset.

As repetitive acquisitions are needed for calculation of an average single sweep will not be compatible.

8.4 Roll mode capture/display

Roll mode means that the signal(s) will be continuously acquired without the need for a trigger. Hence all controls, displays and readouts for the trigger and ZOOM will be disabled. The readout will show "rol".

The result of the last acquisition will be displayed at the right hand edge of the graticule, all formerly acquired signals will be shifted one address to the left. The result at the left hand screen edge will be dropped. There is no waiting for a trigger and thus the hold-off time is minimum. As in any other mode the signal acquisition may be stopped and restarted any time with the RUN/STOP pushbutton.

In roll mode the time base available is limited to 50 s/cm to 50 ms/cm. Faster time bases do not make sense as the signal could not be observed any more.

In case the time base was set outside the limit cited it will be automatically changed to the next value within the limits upon entering this mode.

8.5 Peak Detect Auto Off

On Peak Detect Auto mode this mode of acquisition will be automatically selected if YT and time base speeds of 20 ms/cm to 2 ms/cm were chosen. This mode is only available with: Refresh, Envelope, Average, and Single sweep – The readout will show "PD" preceding the symbol for the operating mode selected.

At slow sweep speeds the sampling rate will be low, i.e. there are relatively large gaps between samples. Glitches occurring during those gaps will go by unnoticed. With Peak Detect, however, the highest sampling rate will be used such that glitches will be caught. The samples will be looked at and the ones with the highest values stored and displayed.

8.6 Random Auto Off

Provided single sweep was not selected Random Sampling will be automatically selected beginning at a certain sweep speed. The time base setting will be indicated in the readout, e.g. "RS: 10 GSa" (= Random sampling with 10 GS/s effective sampling rate), the real time time base speed will be 5 ns/cm. Without Random Sampling "RS" Real Time Sampling will be used with a maximum sampling rate of 1 GS/s (one channel only) or 500 kSa/s (two channel mode).

Random Sampling requires repetitive signals, each signal period will contribute one sample. At an effective sampling rate of 10 GS/s the time difference from sample to sample along the signal period will be 0.1 ns. However, note that with random sampling the samples are not taken in sequence along the signal period but randomly with respect to it. Random Sampling allows to generate the 200 points per cm in X direction at the fastest time base of 5 ns/cm.

Remark: 5 ns/cm are also available in other modes. In Real Time Sampling mode and 1 GS/s on one channel each 1 ns a sample is taken, hence at 5 ns/cm there are 5 points per cm. The "missing" 195 points are generated by interpolation using $\sin x/x$.

⑨ SAVE/RECALL

This pushbutton will open up a menu. The number of choices in this menu is dependent upon whether there is analog or DSO mode.

9.1 Analog and DSO modes

Under "Save/Recall" the current instrument settings may be saved or settings saved earlier recalled. There are 9 nonvolatile memories available.

9.1.1 Saving the actual settings

Upon pressing the pushbutton the submenu "Front Panel Save" will be accessed. A memory number will be offered (1 to 9) which can be changed by the INTENS knob ②. By pressing "Save" all settings will be saved in the memory location the number of which was selected.

9.1.2 Recall the actual settings

In the submenu "Front Panel Recall" a memory number will be displayed (1 to 9) which can be changed with the INTENS knob ②. Pressing the pushbutton "Recall" causes loading of the settings stored.

9.2 DSO mode

The menu options described in 9.1.1 and 9.1.2 are also available in DSO mode. Additionally, the menu options "Reference Save" and "Reference Display" will be available. A reference is a signal which was resp. can be stored away for later reference to it 9 nonvolatile memory locations are provided.

9.2.1 Reference Save

9.2.1.1 Source x C

In the submenu the source can be selected with the INTENS knob ②. Signals from the logic inputs CH3 and CH4 can not be stored as references.

9.2.1.2 Destination RE x C

There are 9 memory locations available into which reference signals from the source selected before can be stored. Use the INTENS knob ② for selection.

9.2.1.3 Save

Pressing "Save" will store the signal from the source selected into the memory selected.

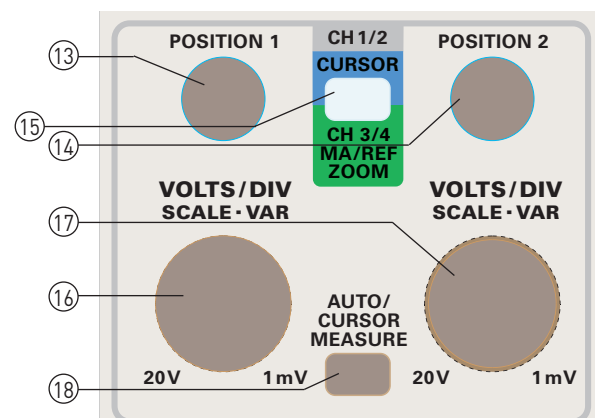

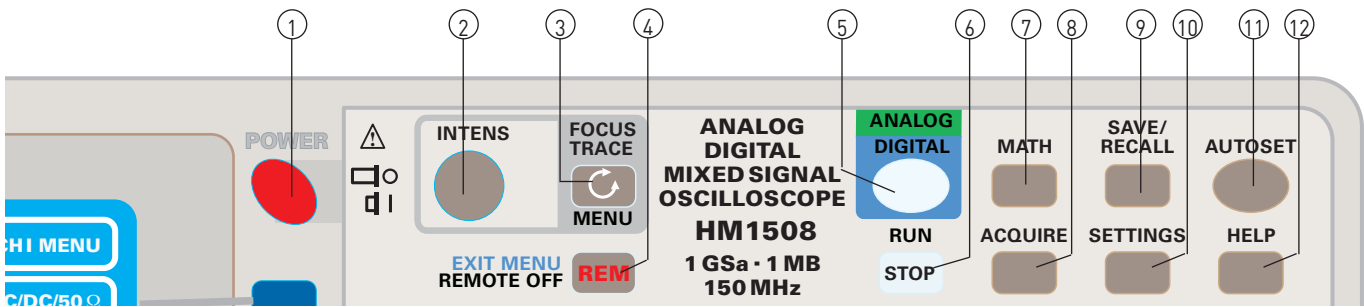

9.2.2 Reference Display



Attention!
Switching the "Reference Display" "On" is not possible if channel 3 and 4 are switched on. The display of reference signals automatically switches previously displayed mathematic signal(s) off and vice versa.

9.2.2.1 RE x, On Off, associated settings

When in this submenu using the INTENS knob will allow selection of 2 reference signals which can then be displayed alongside with 2 input signals.

9.2.2.2 RE x

After calling this function the memory location can be selected with the INTENS knob (2). (RE 1 to 9)

9.2.2.3 On Off

With the pushbutton on/off control is possible. When the contents of the reference memory are displayed, the memory number is indicated with RE x (x = 1 to 9) at the right hand screen side. Switching to "on" will produce another menu item ("Assoc.Set").



Please note:
If both reference displays are "on" and if both memory locations are identical (e.g. RE1, RE1) the signal will be displayed twice on the same spot.

9.2.2.4 Associated settings

If the pushbutton labelled "Assoc.Set." is depressed the readout will show all oscilloscope settings which were loaded into the reference together with the signal. The signal parameters may be recalled.

10 SETTINGS

Pressing this pushbutton will open the SETTINGS menu which offers the following submenus:

10.1 Language

In this submenu the language can be selected: English, German, French are available for choice.

10.2 Misc (Miscellaneous)

10.2.1 Contr.Beep On Off

Switches the acoustical signal on or off, which informs about CW or CCW positions of knobs.

10.2.2 Error Beep On Off

Will turn the acoustical error signal on or off.

10.2.3 Quick Start On Off

In off the HAMEG logo, the type and the version number will not be shown, the instrument will be ready immediately.

10.2.4 Menu Off time

With the INTENS knob (2) the time of menu display may be determined. EXIT MENU will terminate a menu on the spot.

In "Man." mode the menu can be left:

- by pressing EXIT MENU.
- by pressing another pushbutton.
- by pressing the same pushbutton again with which the menu was called.

10.3 Interface

This menu shows the interface parameters which can be selected as usual.

10.4 Display

This submenu offers several modes of display:

10.4.1 Dots

In this mode the samples are shown as what they are, i.e. dots (points). This representation is valuable for judging whether enough samples were gathered in order to reconstruct a signal sufficiently.

10.4.2 Vectors

In this mode the sampling points are interconnected by drawing straight lines. If there are only few samples sin x/x interpolation is used to "create" intermediate points which are then joined by straight lines.

10.4.3 Optimum display

In this mode minimum and maximum signal values acquired are taken into consideration and displayed in Vectors mode. This makes sense as up to 1 MByte samples may be acquired, but only up to 2 KBytes per channel can be displayed, hence possibly min or max values may not be shown. Otherwise the display is as described above.

11 AUTOSET

Choosing AUTOSET will cause an automatic instrument setting, dependent upon the signal proper which selects positions, signal amplitude and time base for a reasonable display. The choice of analog or DSO mode will not be affected. In component test mode (available only in analog mode), XY mode, or ADD automatically dual channel mode will be selected. If dual channel or CH1 or CH2 were previously chosen this will remain.

The DSO modes Roll, Envelope or Average will be changed to refresh mode.

AUTOSET will further set the intensity to an average value if it was set too low. If a menu was opened it will be turned off by AUTOSET. During the display of HELP texts AUTOSET is not available.

⑫ **HELP**

Pressing the HELP pushbutton will turn the signal display off and display the help text. If a menu was opened the help text will refer to this menu resp. to the special menu or submenu option selected. If a knob is moved another help text referring to this knob will appear. Press HELP again to deactivate the text.

⑬ **POSITION 1**

This knob can assume various functions which depend upon the operating mode, the functions selected with the CH1/2-CURSOR-CH3/4-MA/REF-ZOOM-pushbutton ⑮ and the menu option selected.

13.1 Y position

13.1.1 Y position CH1 (Analog and DSO modes)
POSITION 1 will set the Y position of CH1 provided there is YT mode and the pushbutton CH1/2-CURSOR-CH3/4-MA/REF-ZOOM-pushbutton ⑮ is not illuminated.

13.1.2 Y position CH3 (DSO mode only)
POSITION 1 will be active for CH3 if: YT mode, CH3 and CH4 turned on, [CH3/4 pushbutton ⑯ > Channels On] and after pressing CH1/2-CURSOR-CH3/4-MA/REF-ZOOM-pushbutton ⑮ the function "CH3/4" was selected. The pushbutton will light up green.

13.1.3 REF (reference) signal position (DSO mode only)
The POSITION 1 control functions as the position control for the signals stored in the reference memory if these conditions are fulfilled:

1st A reference signal must be on display [SAVE/RECALL ⑨ > Reference Display > (upper display area) REx (x = number of memory location, select with INTENS) > On (with or without associated settings).

2nd After pressing CH1/2-CURSOR-CH3/4-MA/REF-ZOOM-pushbutton ⑮ > Math./Ref. was selected, the pushbutton will light up green.

13.1.4 Mathematics signal position.
The POSITION 1 control will assume the function of position control for mathematics signals after the following procedure: Press the MATH pushbutton ⑦ > Display [upper display area], select an equation with the INTENS knob ② (MA1.. MA5), press the CH1/2-CURSOR-CH3/4-MA/REF-ZOOM-pushbutton ⑮, select "Math./Ref." The pushbutton will light up green.

13.1.5 Y position of 2nd time base B (Analog mode).
The POSITION 1 control will assume the function of Y position control of the signal displayed by time base B in alternate time base mode after the following procedure. This is convenient in order to be able to separate the displays of the (same) signal with both time bases on the screen. Press the HOR ⑳ pushbutton > "Search". Press the CH1/2-CURSOR-CH3/4-MA/REF-ZOOM-pushbutton ⑮, select the function "TB B". The pushbutton will light up green.

13.1.6 Y position for ZOOM (DSO mode.)
This is the equivalent of the former in DSO mode, where the function is called ZOOM. The POSITION 1 control will assume the function of Y position control of the zoomed signal after the following procedure. Again, the intent is to be able to separate the two displays of the (same) signal on the screen in alternate

time base mode. Press the HOR ⑳ pushbutton > "Search". Press the CH1/2-CURSOR-CH3/4-MA/REF-ZOOM-pushbutton ⑮, select "TB B". The pushbutton will light up green.

13.2. X position in XY mode (Analog and DSO modes)
POSITION 1 will function as X position control of CH1 in XY mode and provided the CH1/2-CURSOR-CH3/4-MA/REF-ZOOM-pushbutton ⑮ is not illuminated.

 **Note:**
The HORIZONTAL control ⑳ will also be functional in XY mode.

13.3. CURSOR position (Analog and DSO modes)
The POSITION 1 control will function as Y position control of the cursors if the following conditions are met: The CURSOR display must have been activated (AUTO/CURSOR-MEASURE pushbutton ⑱ > Cursors > Cursors On pushbutton depressed). Press the CH1/2-CURSOR-CH3/4-MA/REF-ZOOM-pushbutton ⑮, select "Cursors" or "Cur. Track". The pushbutton will light up in blue.

 **Please note:**
The function "Cur. Track" is only available if two cursors are indeed displayed, then both cursors can be moved simultaneously (tracking) without a change of their respective positions.

⑭ **POSITION 2 (knob)**

Also this control may assume diverse functions dependent on the operating mode, the function selected via the CH1/2-CURSOR-CH3/4-MA/REF-ZOOM-pushbutton ⑮ and the menu item activated.

14.1. Y position

14.1.1 Y position CH2 (Analog and DSO modes)
POSITION 2 will function as Y position control of CH2 in Yt mode and if the CH1/2-CURSOR-CH3/4-MA/REF-ZOOM-pushbutton ⑮ is not illuminated.

14.1.2 Y position CH 4 (DSO mode)
POSITION 2 control will control the Y position of CH 4 in Yt mode if the following conditions are met: CH 3 and CH 4 must be activated [CH3/4 pushbutton ⑯ > "Channels On"]. Press CH1/2-CURSOR-CH3/4-MA/REF-ZOOM-pushbutton ⑮, select "CH3/4". The pushbutton will light up green.

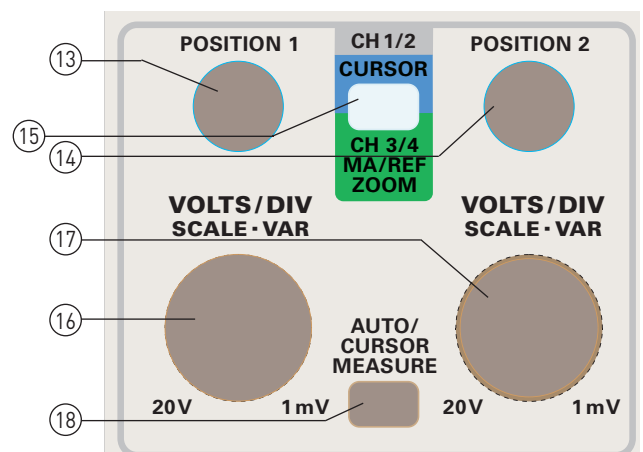

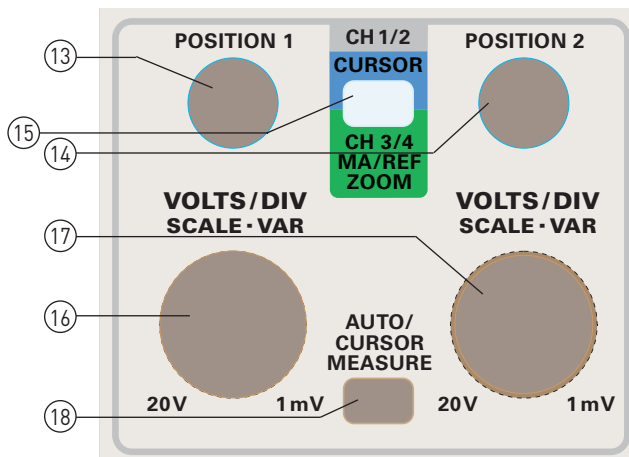

- dark:** Y position and vertical sensitivity CH1 and CH2.
- blue:** Y position of cursors.
- green:** Y position and display height of:
 - CH3 and CH4.
 - Mathematics signal(s)
 - Reference signal(s)
 - ZOOM or time base B display of signal(s)

16 VOLTS/DIV-SCALE-VAR-knob

This knob is a multi function CH1 control.

16.1 Selection of vertical sensitivity

Provided VAR on pushbutton CH1 ⑩ is not illuminated the sensitivity will be calibrated. Turning the control CCW will decrease, turning it CW will increase the sensitivity. 1 mV/cm to 20 V/cm can be selected in a 1-2-5 sequence. The readout will display the calibrated sensitivity (e.g. "CH1: 5mV.."). Depending on the sensitivity selection the signal will be shown with smaller or greater amplitude.



Please note:

This sensitivity selection is always active, e.g. also, if CH2 only was chosen. In that case CH1 may be used as trigger source.

16.2 Variable control

Select this function with the CH1 pushbutton ⑩ > Variable On. VAR on the CH1 pushbutton will light up. The readout will add a ">" to the sensitivity indication ("CH1>5mV..") in order to show that the sensitivity is now uncalibrated. The results of cursor measurements will be flagged accordingly.

In this mode the sensitivity can be changed with the VOLTS/DIV-SCALE-VAR control knob from 1 mV/cm to > 20 V/cm.

16.3 SCALE (DSO mode)

The display height of CH3, a mathematic signal resp. a reference signal can be changed after the function CH3/4 or Math./Ref. is selected in the Pos./Scale-menu. The latter is called by pressing the CH1/2-CURSORS-CH3/4-MA/REF-ZOOM-pushbutton ⑮.

17 VOLTS/DIV-SCALE-VAR knob

This multi function control belongs to CH2.

17.1 Selection of vertical sensitivity

The sensitivity will be calibrated provided VAR on the CH2 pushbutton ⑪ is not illuminated. Turning the control CCW will decrease, turning it CW will increase the sensitivity. The sensitivities can be selected from 1 mV/cm to 20 V/cm in a 1-2-5 sequence. The readout will show the sensitivity (e.g. "CH2:5mV.."). Depending on the sensitivity the signal will be displayed with smaller or greater amplitude.



Please note:

The sensitivity control is always active, i.e. also if CH2 is not selected. CH2 may then still be used e.g. as a trigger source.

17.2 Variable control

The variable control is activated by pressing the CH2 pushbutton ⑪ > Variable On. VAR on the pushbutton will light up. The readout will add the ">" preceding the sensitivity (e.g. "CH2>5mV..") in order to indicate that the sensitivity is uncalibrated. The results of cursor measurements will be labelled accordingly.

In this mode the sensitivity may be changed continuously with the VOLTS/DIV-SCALE-VAR control from 1 mV/cm to > 20 V/cm.

14.1.3 Y position of reference signals (DSO mode)

The POSITION 2 control will function as Y position control of reference signals if the following conditions are fulfilled:

1st A reference signal must on display. (SAVE/RECALL pushbutton ⑨ > Reference Display > (upper display area) Rex (x = number of memory location, select with INTENS) > On (with or without associated settings).

2nd Press CH1/2-CURSORS-CH3/4-MA/REF-ZOOM-pushbutton ⑮ > Math./Ref. The pushbutton will light up green.

14.1.4 Y position of mathematics signals (DSO mode)

The POSITION 2 control functions as Y position control for mathematics signals, if the following conditions are fulfilled: Press the MATH pushbutton ⑦ > displays (upper display area), select an equation with the INTENS knob ② (MA1.. MA5). Press the CH1/2-CURSORS-CH3/4-MA/REF-ZOOM-pushbutton ⑮, select Math./Ref. The pushbutton will light up green.

14.2 Y position of CH2 in XY mode (Analog and DSO modes.)

POSITION 2 will function as the Y position control of CH2 in XY mode provided the CH1/2-CURSORS-CH3/4-MA/REF-ZOOM-pushbutton ⑮ is not illuminated.

14.3 Y position of cursors (Analog and DSO modes)

The POSITION 2 control will function as Y position control of the cursors if the following conditions are met: The cursors must be activated (Press AUTO/CURSORS-MEASURE pushbutton ⑱ > Cursors > Cursors On), press the CH1/2-CURSORS-CH3/4-MA/REF-ZOOM-pushbutton ⑮ select "Cursors" or "Cur. Track". The pushbutton will light up blue.



Note:

The function Cur. Track (cursor tracking) is only available if 2 cursors are on display. The cursors will then be moved simultaneously (tracking) without changing their respective positions.

⑮ CH1/2-CURSORS-CH3/4-MA/REF-ZOOM-pushbutton

This pushbutton calls a menu which allows to select the functions of the controls POSITION 1, 2 and VOLTS/DIV. With mathematics functions, reference and CH3 resp. CH4 signals this will also affect in some way the SCALE function which is changed by the VOLTS/DIV controls.

The pushbutton will signal the function activated corresponding to the front panel labelling:

17.3 SCALE (DSO mode)

The display height of CH4, a mathematic signal resp. a reference signal can be changed after the function CH3/4 or Math./Ref. is selected in the Pos./Scale-menu. The latter is called by pressing the CH1/2-CURSOR-CH3/4-MA/REF-ZOOM-pushbutton ⑮.

⑮ AUTO/CURSOR-MEASURE pushbutton

Pressing this pushbutton will open the menu "Measurement" which offers the submenus > "Cursors" and "Auto".

If the submenu Cursors was selected and a measuring mode "Cursors On" must be activated too, in order to generate the cursor line(s) on the screen. The measurement result will be shown in the readout!



Please note:

In order to move the cursors it is necessary to press the pushbutton CH1/2-CURSOR-CH3/4-MA-REF-ZOOM ⑮ and look for the menu "Pos./Scale". In this menu the selection of "Cursors" (long lines) or "auxiliary cursors" (short lines) or other symbols will determine which cursor lines/symbols can be moved by the POSITION 1 and 2 controls.

18.1 Cursors (Analog and DSO modes)

Depending on the operating mode (Yt or XY) this submenu will offer various cursor measuring functions which will affect as well the cursor lines as their position.

18.1.1 Cursors On Off

With "Cursors On" the CURSORS and the results of cursor measurements will be displayed by the readout in the top right corner of the screen. (e.g. $\Delta V[CH2]:16.6 \text{ mV}$). If a variable control was activated, the readout will indicate this by replacing the ":" by a ">".

18.1.2 Meas. Type

If this function is activated one of the measurement modes offered may be selected with the INTENS knob ②. In most cases the unit going with a mode will be shown also.

18.1.3 Unit

In the modes "Ratio X" and "Ratio Y" the INTENS knob symbol ② will be shown in addition to a unit, this may then be used to change the unit.

"rat" (ratio), display of ratios

In this mode the ratios of duty cycles or amplitudes may be determined with the CURSORS. The distance between the long CURSOR lines is equal to 1.

"%" (percent), display of percentages

The distance between the long CURSOR lines is equal to 100%. The result will be determined by the distance of the short auxiliary cursor line to the long reference line (lower resp. left), if appropriate with a negative sign.

"°" (degree), measurement of degrees

The distance between the long CURSOR lines is equal to 360 degrees and must be exactly as long as a signal period. The measurement result will be determined from the distance between the reference line to the short auxiliary cursor line. If appropriate with a negative sign. For further information please consult "Measurements of phase differences in dual channel mode (Yt)" in the section "First time operation and presettings".

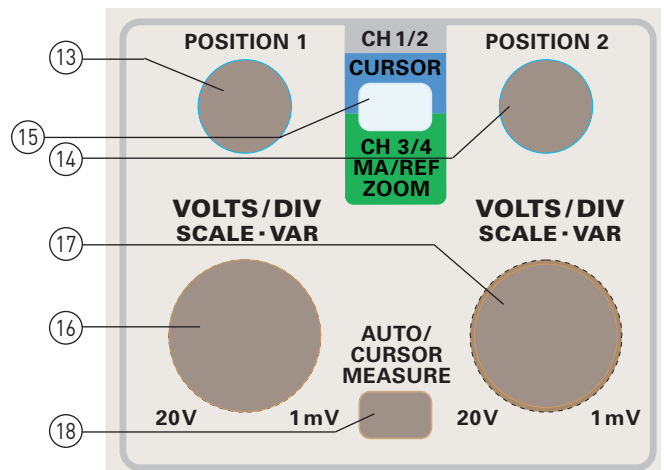

"π"

One period of a sine wave is equal to 2π , hence the distance between the two long CURSOR lines must be set to one period. If the distance between the reference line and the short CURSOR line equals 1.5 periods, " 3π " will be displayed. If the short cursor line is left of the reference line a negative sign will be shown.

18.1.4 Respect

It may be necessary to determine for which signal resp. channel the CURSOR measurement shall be valid. This is signalled by showing the INTENS knob ② signal next to the channel number. After selection of the signal source, the CURSOR lines must then be positioned to the signal or portions of it displayed by this channel.

18.2 Auto (Analog mode)

Depending on the operating mode this submenu offers various automatic measurements of the trigger signal. The following conditions must be met:

- a) For frequency or period measurements sufficient trigger signals must be available. Use normal triggering for signals < 20 Hz. Please note that signals of very low frequency may require seconds to complete one measurement.
- b) In order to measure DC or the DC content of a signal the input channel as well as the trigger must be set to DC coupling.

Further notes:

- Due to the limited frequency response of the trigger channel the accuracy will decrease with increasing frequency.
- The frequency responses of the vertical channel and the trigger channel differ substantially, this may affect the signal display.
- When measuring very low frequency signals the display will follow the signal.
- When measuring pulse signals there may be an influence of the duty cycle or the slope selected on the accuracy of the result.
- The signal must remain within the graticule area, i.e. the input amplifiers must not be overdriven.



Please note:

Complex signals should be measured using the CURSORS.

18.2.1 Auto On Off

If Auto is On the result of the automatic measurement will be shown in the readout in the top right corner. (e.g. dc(Tr):100µV. (Tr) points out that it refers to the trigger signal. Sometimes a “?” will be displayed, this indicates that there is no or an insufficient signal.

If a variable is activated und thus the sensitivity or time base uncalibrated the “:” will be replaced by a “>” symbol.

18.2.2 Meas. Type (measurement type).

The measurement type can be selected with the INTENS knob ②.

18.2.3 Respect

Tr indicates that the measurement is done with respect to the trigger signal. If e.g. the CH1 signal is used for triggering, the result will be with respect to that signal.

18.3 Auto (DSO mode)

Depending on the operating mode this submenu offers various automatic measurements. The display in the “reference” field will signal to which source the result belongs. (Tr = trigger signal or the signal of the channel shown.)

See the hints in 18.2 regarding period (trigger period) or frequency (trigger frequency) measurements.

For voltage measurements the result will be calculated from the displayed signal data and the signal data selected with “Respect”.

Please note:
Complex signals should be measured with CURSOR.

18.3.1 Auto On Off

If Auto is On the readout will display the result of the automatic measurement in the top right corner. (e.g. DC(CH2):100µV). (CHx) denotes the source channel, (Tr) the trigger signal. Sometimes a “?” may be displayed, if there is no signal or an insufficient one.

If a variable is activated and the sensitivity or time base thus uncalibrated the “:” will be replaced by a “>” symbol.

18.3.2 Meas. Type (measurement type)

If this function is activated the mode can be selected with the INTENS knob ②, the display in the “Respect” field will change accordingly.

In one channel only mode the active channel will be indicated. In those modes where 2 channels are activated the INTENS knob symbol ③ will be shown. After pressing the “Reference” pushbutton the reference channel may be selected with the INTENS knob ②.

18.3.3 Respect

Tr indicates that the measurement is done with respect to the trigger signal. If e.g. the CH1 signal is used for triggering, the result will be with respect to that signal.

In case of voltage measurement is done with respect to the active channel. In those modes where several channels are activated, the INTENS knob symbol ③ indicates that different channels can be selected.

⑱ LEVEL A/B knob

The LEVEL control allows to set the trigger level, i.e. the voltage resp. signal level, which will generate a trigger to start the time base whenever the signal passes that level. In most Yt modes

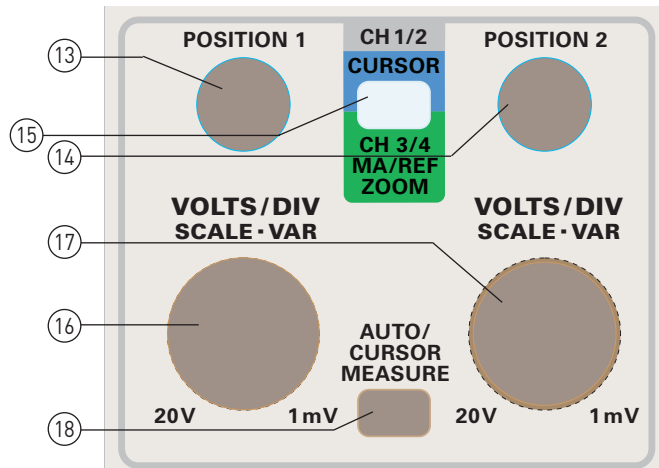

the readout will show a symbol the vertical position of which indicates the signal point which will trigger. The trigger symbol will be “parked” on the second graticule line from the bottom in those modes where there is no direct relationship between trigger signal and trigger point.

In normal trigger mode the LEVEL control will move the trigger symbol anywhere. In automatic peak-to-peak detection mode the level can only be selected between the signal’s peak values.

The movement of the trigger symbol is vertical only. The range of this symbol is limited in order to prevent that this symbol will overwrite other readout information. As soon as the trigger symbol leaves the graticule its form will change, this change signals in which direction the trigger symbol left the graticule.

Analog mode only: Depending on the time base mode the LEVEL control will affect the time base A or B triggering. Press the HOR pushbutton ⑳ in order to select the time base mode in the “Time base” menu. In “Search” mode (alternate time base mode) the last trigger level setting for time base A will remain valid (graticule left) if time base B is switched to triggered mode. (Menu “Time base”: set B trigger to positive or negative slope). Thereafter the LEVEL A/B control will control the time base B trigger, a second trigger point symbol will be shown and marked with “B”.

⑳ MODE (pushbutton)

Pressing this pushbutton will open the “Trigger” menu, where Auto, Normal, Single (sweep triggering) can be selected. Choosing “Slope” will allow to trigger on any signal shape. For video signals select “Video” and press the FILTER pushbutton ㉑ in order to find a choice of special trigger modes for composite video signals.

In DSO mode also “Logic” will be offered, allowing to trigger on logic signals. The explanations can be found in: FILTER ㉑ and SOURCE ㉒.

In XY mode the pushbuttons MODE ㉑, FILTER ㉑ and SOURCE ㉒ are disabled as there is no triggering in XY mode.

20.1 Auto (trigger)

Automatic triggering [Auto] is active if the NORM display ㉓ is not illuminated. In “Auto” the analog time base resp. signal capture (DSO mode) will be periodically started even if there is no signal or when no triggers are generated because the set-

tings are incorrect. Signals of < 20 Hz can not be triggered as the automatic start will have occurred before the signal arrived. Automatic triggering is possible with or without peak detection. The LEVEL A/B ⑱ control will be active in both modes.

In peak detection mode the range of the level control is limited to the peak-to-peak voltage of the signal. Without peak detection any level can be set. If the trigger level is set such that no triggers are generated the automatic triggering will nevertheless start the time base. The signal will thus remain visible but will be untriggered.

Whether peak detection is active or not depends on the mode and the settings in "FILTER" (trigger coupling). The mode active will be shown by the behaviour of the trigger point symbol when turning the LEVEL knob.

20.2. Normal (trigger)

If the NORM-LED ⑳ lights up normal triggering was selected. In normal trigger mode both the peak detection and the automatic time base start will be disabled. Hence if there is no sufficient trigger signal the screen will remain dark in analog mode. In DSO mode signal capturing will also stop unless the roll mode was selected.

In this mode there is no lower frequency limit for signals.

20.3 Single (sweep/capture)

In single sweep/capture mode the time base selected will accept only one trigger for one sweep/capture after it was armed. The NORM-LED will light up, Auto triggering is disabled.

For further information about the precise operation see RUN/STOP pushbutton ⑥ description.

⑳ FILTER (pushbutton)

After this pushbutton is depressed it will depend on the settings chosen in MODE ⑳ (Edge, Video, Logic) which menu will be offered. In XY mode the pushbuttons: MODE ⑳, FILTER ㉑ and SOURCE ㉒ are disabled as XY displays can not be triggered.

21.1 Menu: Slope

The menu "Edge" will appear if "Edge" was selected in the "Trigger" menu to be called with MODE ⑳ pushbutton and after the FILTER ㉑ pushbutton was depressed. For further information see "Trigger coupling" (Menu "FILTER") under the heading "Triggering and time bases" and the instrument specifications. The following settings are available:

21.1.1 Trig. Filter

- **AC:** The trigger signal is AC coupled via a large capacitor in order to reach a low cut-off frequency.
Readout: "Tr:Source, Slope, AC"
- **DC:** The trigger signal is DC coupled. No peak triggering is possible.
Readout: "Tr: Source, Slope, DC"
- **HF:** AC coupling with a small capacitor suppressing low frequency signals. Hence the signal display and the trigger signal derived are not any more identical, the trigger point symbol will be "parked" in DSO mode and will not react to the LEVEL A/B ⑱ control. In analog mode the trigger point symbol is switched off. As a combination of HF coupling and LF or Noise Reject is not meaningful both menu options will not be shown.
Readout: "Tr:Source, Slope, HF"

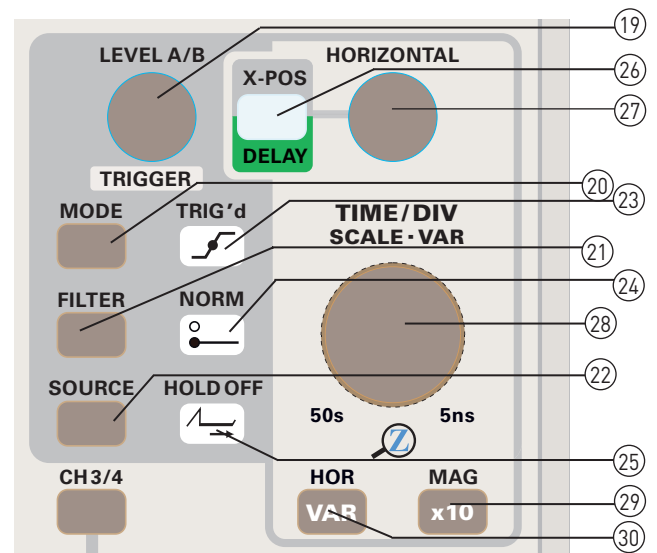

- **LF:** The trigger signal is sent through a low pass in order to suppress high frequency components. As this will already suppress hf the noise rejection mode will be set to OFF automatically.
Readout: "Tr:Source, Slope, AC or DC, LF".
- **Noise Reject:** Noise rejection (reduction) means a reduced trigger amplifier bandwidth and consequently less trigger signal noise.
Readout: "Tr:Source, Slope, AC or DC, NR".

21.1.2 Slope

"SLOPE" determines whether the rising or falling portion of a signal shall trigger, the level is set with the LEVEL A/B ⑱ control.

In "Both mode" both slopes will trigger, this is also true in single sweep mode. This allows e.g. the display of eye diagrams.

21.2 Menu: Video

In order to reach the menu "Video" proceed as follows: Press MODE ⑳ to open the "Trigger" menu, select "Video", then press the FILTER ㉑ pushbutton. Further information can be found under "Video" (tv signal triggering) in the chapter "Triggering and time bases" and in the instrument specifications. The following settings are available:

21.2.1 Frame, Line.

Depending on the setting chosen triggering will be on frame or line sync pulses. The selection will also affect other menu items.

Readout: "Tr:Source, TV".

21.2.1.1 Frame

- **ALL:** In this mode the sync pulses of each half frame can trigger.
- **Even:** In this mode only the sync pulses of even half frames can trigger.
- **Odd:** In this mode only the sync pulses of odd half frames can trigger.

21.2.1.2 Line.

- **All:** In this mode all line sync pulses can trigger.
- **Line No:** The line number with its line pulse that is used for triggering can be selected with the INTENS knob ㉒.
- **Line min:** One pushbutton operation will be sufficient to switch back to the lowest possible line number.

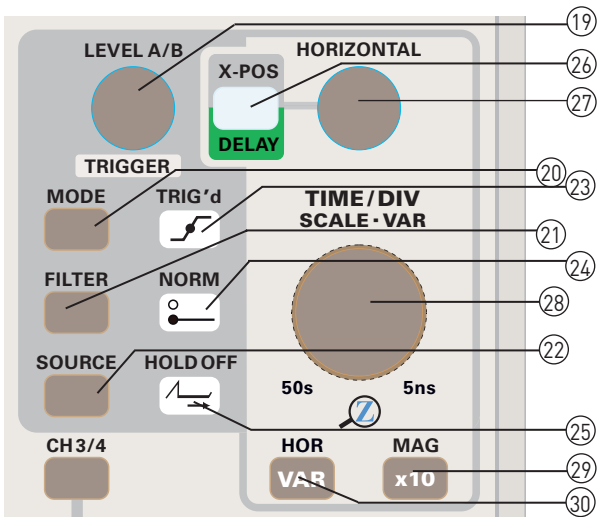

21.2.2 Norm

The pushbutton allows the selection of the US standard of 525 lines and 60 Hz or the European standard with 625 lines and 50 Hz. With any change of standard the line number will be automatically changed, too.

21.2.3 Polarity

Composite video signals may have both polarities. Selection of the right polarity is vital as the scope should be triggered by the sync pulses and not the video content. Positive polarity is defined by the video content being more positive than the sync signals and vice versa. If the polarity was wrongly selected there will be no triggering at all, an untriggered display or no signal capture.

21.3 Menu: Logic (DSO mode only)

The following description refers to the selection of the trigger source and the logic levels available in the "Trig. Source" menu called with the pushbutton 22.

The following settings may combined if these conditions are met:

- DSO mode.
- The trigger menu was called with "MODE 20".
- LOGIC was selected there. (Readout: "Tr:Logic".)
- The FILTER pushbutton was depressed and the "Logic" menu reached.

21.3.1 AND, OR: Logic AND or OR.

21.3.2 True, False

This refers to not inverting or inverting the output of the above AND or OR function.

22 SOURCE (pushbutton)

Depressing this pushbutton will call various menus depending on the previously selected mode (MODE 20 pushbutton): Edge, Video, Logic. In XY mode the pushbuttons: MODE 20, FILTER 21, SOURCE 22 are disabled as XY displays can not be triggered.

In the "Trigger SOURCE" menu the source is selected from which the trigger signal is to be taken. The options depend on the actual mode of the scope.

22.1 Edge-/Video-Trigger

22.1.1 CH1

Conditions: Analog or DSO mode, "Edge" or "Video" selected. CH1 will then be the trigger source, no matter whether it is displayed or not. Readout: "Tr:CH1, (Slope), Filter (TV)".

22.1.2 CH2

Conditions: Analog or DSO mode, "Edge" or "Video" selected. CH2 will then be the trigger source, no matter whether it is displayed or not. Readout: "Tr:CH2, (Slope), Filter (TV)".

22.1.3 CH3

Conditions: DSO mode, "CH3/4 On" (pushbutton 29), "Edge". The logic signal on CH3 will trigger if the level conditions are fulfilled. The switching level will be indicated in the "CH3/4" menu if the pushbutton CH3/4 29 is depressed and may then be changed if desired. Readout: "Tr:CH3, Slope".

22.1.4 CH4

Conditions: DSO mode, "CH3/4 On" (pushbutton 29), "Edge". The signal on CH4 will trigger if the level conditions are fulfilled. The level will be indicated in the "CH3/4" menu after depressing the CH3/4 29 pushbutton and may be changed then if desired. Readout: "Tr:CH4, Slope".

22.1.5 Alt. 1/2

Conditions: Analog mode, "Edge"-Triggering". Alternate triggering with the signals from channels 1 and 2 as described in the section "Alternate Trigger" of chapter "Triggering and time bases". Please note that in this trigger mode the apparent time relationships between the two signals on the screen are meaningless and misleading, the relative position of the two signals depends only on their shape and the trigger level selected.

In dual channel mode (DUAL) alternate triggering is only possible in conjunction with alternate dual channel operation. If previously dual trace chopped mode was selected (VERT/XY 22 pushbutton) > DUAL chop it will be automatically changed to alternate mode when alternate triggering is selected. After "Alt. 1/2" is turned off dual trace chopped mode may be selected again. Readout: "Tr:alt, Slope, Filter".

22.1.6 External

In this mode the trigger signal comes from CH4 (CH4 TRIG EXT 28). Readout: "Tr:alt, Slope, Filter".



Please note:

In DSO mode this is only possible when CH3 and 4 are deactivated and "Edge" or "Video" is chosen in the "Trigger" menu (MODE pushbutton 20).

22.1.7 AC Line

The trigger signal is taken from the line which feeds the scope. See also the section "Line triggering" in the chapter "Triggering and time bases". Readout: "Tr:alt, Line, Slope".

22.2 Logic triggering

Logic triggering is only possible in DSO mode. Press MODE pushbutton 20 to call the TRIGGER menu and select LOGIC. Press now the "SOURCE" 22 pushbutton which will present the LOGIC menu where the following settings may be selected:

22.2.1 Source CH1 CH2, X H L

The function pushbutton next to the display "Source CH1 CH2" selects one channel to serve as trigger source. The other function pushbutton will select H = High or L = Low level. X means that both levels will trigger (don't care).

22.2.2 CH3, X H L

The function pushbutton will select H or L. X means that both levels will trigger (don't care).

22.2.3 CH4, X H L

The function pushbutton will select H or L. X means that both levels will trigger (don't care).

23 **TRIG'd display** (not in XY mode)

This LED will light up if the time base receives a trigger signal. It depends upon the trigger signal whether the LED will just blink or remain illuminated.

24 **NORM display**

This display will light up provided "Auto" triggering was not selected. The mode can be selected in the "Trigger" menu called by pressing (MODE 20). The light points out that the screen will remain dark as long as there is no sufficient trigger signal.

25 **HOLD-OFF display** (Analog mode only)

This display will light up if the hold-off time was set to > 0% in order to indicate that the longer than minimum hold-off time may cause a lower rep rate of the time base and thus a darker display. Setting the hold-off time requires pressing the HOR pushbutton 29 which calls the menu "Time base". Only the time base A hold-off time may be changed.

See the section "Hold-off time setting" in the chapter "Triggering and time bases".

26 **X-POS DELAY pushbutton**

This pushbutton allows to change the function of the HORIZONTAL knob 27.

26.1 Analog mode

The pushbutton signals the actually selected function in accordance with the front panel lettering:

dark: X position control

green: Delay time control

26.1.1 X-POS

If the pushbutton is dark the HORIZONTAL -knob 27 functions as X position control, i.e. it moves the signal display horizontally.

The position control is especially useful when the magnifier (MAG. x 10 29) is switched on. The magnifier will magnify the display 10 times around the screen centre, with the control the portion of the signal to be studied can be shifted on-screen.

26.1.2 DELAY

In order to change the function of the HORIZONTAL-knob 27 to "Delay" proceed as follows:

Press the HOR 29 pushbutton which will present the "Time base" menu, select "Search" or "B only", then the function of the knob will be changed if the pushbutton is depressed. It will light up to show that the knob is now the delay time control.

In "Search" mode both traces (time base A and B) alternate. Unlike the former time base "A only" mode, a sector with higher intensity is visible on the A trace. This sector can be moved continuously by the delay time control. The time between the A trace start and the beginning of the intensified sector is the delay time. This information is also displayed in the readout ("Dt: ...") and is an aid to find the position of the intensified sector which may be very small. If time base "B only" is chosen the intensified sector is no longer visible, but the DELAY function still can be used.

Without activated "B Trigger" function, the B time base will be started after the A time base delay time "elapsed".

26.2 DSO mode

The pushbutton will signal the actual function in accordance with the front panel lettering:

dark: The knob functions as X position control.

green: The knob functions as delay time control.

26.2.1 X-POS

If the pushbutton is dark the HORIZONTAL 27 knob functions as X position control of the trigger time, i.e. it moves the trigger point symbol horizontally. This allows to display signal portions before and after the trigger, called Pre-Trigger and Post-trigger. If the trigger point symbol is located on the screen centre the readout will show "Tt:0s", hence the trigger time indication is always referred to the screen centre. Values with a positive sign are Post-Trigger times, such with a negative sign Pre-Trigger times.

If the X-POS DELAY pushbutton is depressed the "Hor.Knob" menu will be called, it contains the following options:

1st **Centre:** Pressing the function pushbutton "Center" will set the trigger time to the screen centre "Tt:0s" which is the standard setting.

2nd **Coarse On Off:** changes the speed of the HORIZONTAL knob.

26.2.2 DELAY

This pushbutton will be illuminated if the "Time base" menu was called with the HOR 29 pushbutton and "Search" selected. The HORIZONTAL 27 knob can then be used to select a portion of the time base display which is to be displayed expanded in time.

In "Search" mode the normal and the expanded displays are displayed simultaneously. The expanded portion of the signal will be shown on the normal display as an intensified sector. The length of this sector is dependent upon the setting of the 2nd "Z" time base which is shown in the readout as "Z..." and is equal to the run time of the Z time base.

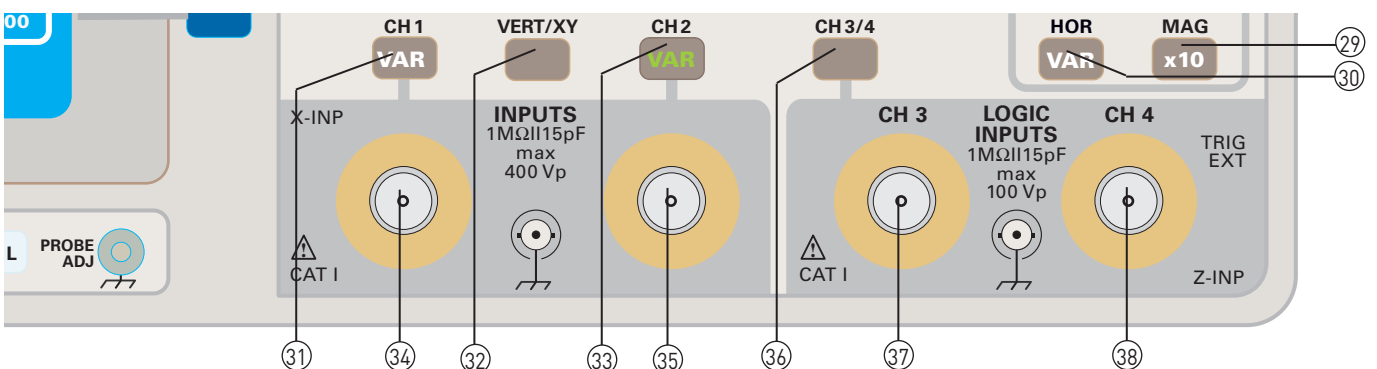

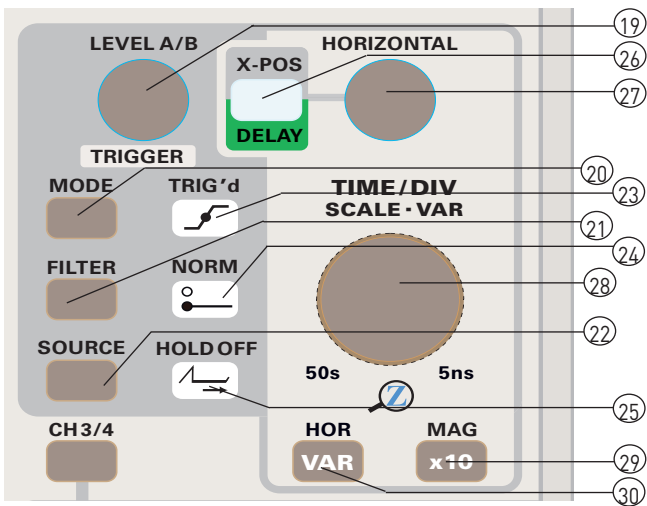

27 HORIZONTAL (knob)

The various functions of this knob depend on the operating mode and are described under X-POS DELAY 26 pushbutton.

28 TIME/DIV.-SCALE-VAR (knob)

This knob is normally used as the time base speed selector, but has also other functions dependent on the operating mode. In XY mode this control is disabled.

28.1 Analog mode

28.1.1 Time base A time/cm selection

This function is active if in the "Time base" menu (HOR 30 pushbutton) "A only" was selected and the option "A variable On Off" was set to Off.

Turning the knob CCW will decrease, turning it CW will increase the time base speed. The time base speed may be chosen between 500 ms/cm... 50 ns/cm in a 1-2-5 sequence and will be calibrated. The readout will show the setting (e.g. "A:50ns").

28.1.2 Time base B time/cm selection

This function is active if in the "Time base" menu (HOR 30 push-button) "Search" or "B only" was selected and the option "B variable On Off" was set to Off.

Turning the control CCW will decrease, turning it CW will increase the time base speed. The speed can be selected between 20 ms/cm.. 50 ns/cm in a 1-2-5 sequence and will be calibrated. The readout will show the speed (e.g. "B:50ns").

The time base B allows to display portions of the time base A display on an expanded time base scale. This implies that the speed of TB B must always be greater than that of TB A. Therefore with the exception of 50 ns/cm TB B can not be set to the same speed as TB A.

Further information is available in the section "Time base B (2nd time base/Delay/Triggering" (Analog mode) in the chapter "Triggering and time bases".

28.1.3 Variable

The TIME/DIV-SCALE-VAR control may also be used to change the time base speed continuously but uncalibrated. VAR will light up on top of the HOR 30 pushbutton in order to warn that the time base is uncalibrated and the knob has now that function.

In order to arrive at that function press HOR 30 which calls the "Time base" menu. Depending whether time base A or B

is selected either "A variable On Off" or "B variable On Off" will be shown. The function pushbutton can then be used to select On/Off.

In order to point out that the time base is now uncalibrated the readout will replace ":" by ">" preceding the time/cm. (e.g. "A>500ns" and "B>200ns"). Also the results of cursor time/period measurements will be marked that way.

28.2 DSO mode

28.2.1 ZOOM OFF (A time base time/cm selection)

Select the menu "Zoom" by pressing HOR 30 and then "Off" in order to set the function of the knob TIME/DIV - SCALE - VAR to time base A speed as in analog mode. If "Zoom Off" is active always the whole memory will be displayed.

Turning the control CCW will decrease, turning it CW will increase the time base speed. Depending on the signal capture/display the time base can be set from 50 s/cm to 5 ns/cm in a 1-2-5 sequence (e.g. "A:50ns") and will be calibrated. There is no variable function as in analog mode.

28.2.2 Search-Zoom only (Zoom time base speed selection)

One of the functions "Search" or "Zoom only" may be selected in the "Zoom" menu after pressing HOR 30. "Zoom Off" is equivalent to time base A in analog mode. With "Zoom only" a portion of the display in Zoom "Off" can be expanded over the whole screen. This is possible because there is a very large memory for signal capture/display. The "Zoom Off" display will present the whole memory contents. With "Search" both the "Zoom Off" and the expanded "Zoom only" displays will be visible. With "Zoom only" only the expanded display will show up.

The Zoom time base speed will be indicated in the readout "Z:..." and is calibrated. Turning the knob CCW will decrease, turning it CW will increase the time base speed. This can be selected from 20 ms/cm to 5 ns/cm in a 1-2-5 sequence. The maximum expansion is 50,000 times ("A:10ms" and "Z:200ns".)

29 MAGx10 (pushbutton)

In analog mode only: pressing this pushbutton will turn on the x 10 magnifier. No menu will be shown.

If "x10" is illuminated on the MAG pushbutton the magnifier is activated. The adjusted time/cm will be shown in the top left readout.

Depending on the time base mode turning on the magnifier will have these effects:

29.1 "Time base A only"

The display will be expanded around the screen centre by a factor of 10, the time/cm adjusted accordingly.

29.2 "Search" (A and B times bases alternated)

The time base A speed will not be affected. The time base B speed will be increased by a factor of 10, hence the time base B display will be expanded 10-fold in X direction.

29.3 "B only":

The time base B speed will be increased by a factor of 10 and the display hence expanded 10-fold in X direction.

30 HOR (pushbutton)

This pushbutton will open the "Time base" menu the contents of which depends on the operating mode selected.

30.1 Analog mode

The following modes are available:

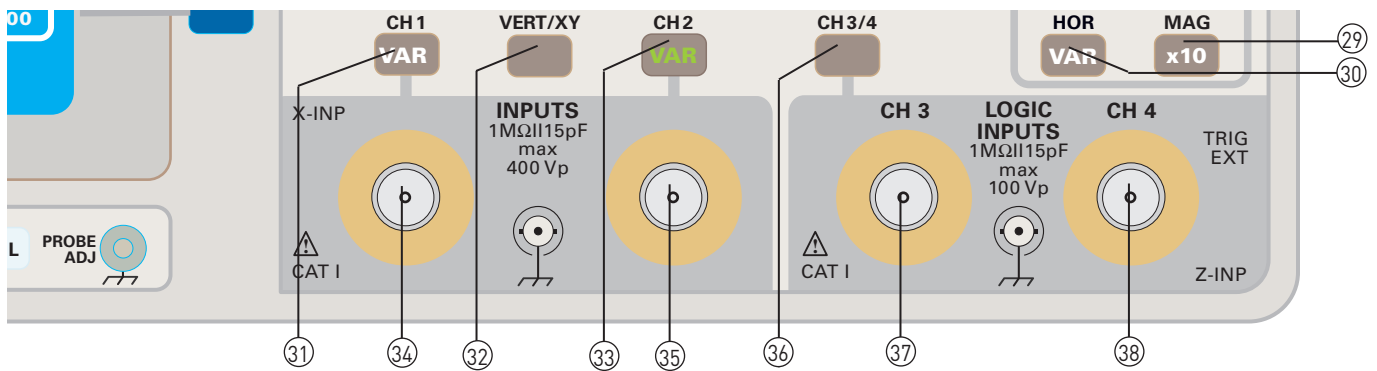

30.1.1 A only

Only the time base A will be operative. The readout will thus only show "A..." in the top left corner. The TIME/DIV-SCALE-VAR knob will set the time base A speed. With the MAG x10 pushbutton the display may be expanded around the screen centre, increasing the speed by 10. If the mode is changed from time base A to "Search" or "B only" all settings of time base A remain intact including triggering.

30.1.2 Search

This mode implies alternate time base operation. The readout will show the speeds of both time bases ("A..." and "B..."). The TIME/DIV-SCALE-VAR knob will set the time base B speed.

In alternate time base mode part of the time base A display will be intensified. The horizontal position of the intensified portion may be shifted using the HORIZONTAL knob, provided its function was set to "Delay", this is the case if the X-POS DELAY pushbutton is illuminated. The length of the intensified sector is determined by the speed of time base B and is equal to the run time of B. Hence this intensified portion of A will be spread over the full screen as displayed by B and thus expanded. The Y position of the signal is the same when displayed with either A or B. This means, however, that both displays will be written over each other. In order to separate them on the screen for better readability an artificial Y offset may be added to the time base B display. Press the CH1/2-CURSOR-CH3/4-MA/REF-ZOOM pushbutton which calls the "Pos./Scale" menu. Press the function pushbutton "TB B", this will cause the POSITION 1 knob to act as the position control for the time base B display. [Trace separation.] See also 13.1.5 Y position 2nd time base. This function makes sense only in "Search" and is unavailable in any other. Also in "Search" the 10 x magnifier is available by pressing the pushbutton MAG x10. The magnifier will affect solely time base B.

30.1.3 "B only":

In this mode only time base B will be displayed, the readout will thus only show the time base B speed in the top left corner ("B..."). The TIME/DIV-SCALE-VAR knob will set the time base B speed.

The 10x magnifier is available by pressing MAG x10 and will expand the display around the screen centre.

30.1.4 B trigger - Edge

In this mode time base B will not start immediately after the delay time set elapsed, but it will be only set ready waiting for a signal trigger. This has the advantage that any jitter is removed, but the delay time adjustment will now only have the effect that the time base B display will jump from signal period to period. In this setting a positive slope will trigger.

The (trigger) LEVEL A/B knob will set the trigger level for B. Only normal triggering and DC-coupling are possible. All

parameters of time base A remain stored and preserved. (LEVEL, auto or normal, Slope, coupling). In addition to the delay time ("Dt:...") also the B trigger parameters are shown in the readout: "BTr:slope, DC". In "Search" mode the trigger point symbol will be preceded by "B". As mentioned changing the delay time will not cause a continuous move of the intensified portion of the time base A display and the time base B display, but jumps from signal period to period.

If the trigger level symbol of time base B is shifted outside the signal representation by time base A there will be no triggering of time base B any more and thus no time base B display. The same holds in time base B only mode.

30.1.5 B trigger - Edge

Except for the negative edge the function is identical to the one described above (30.1.4).

30.1.6 B trigger - OFF

Time base B will be started upon the end of the delay time set. The delay time can be changed continuously in this mode which can be watched on the intensified sector of the time base A display. The disadvantage here is that with very long delay times jitter of the time base B display may crop up.

As time base B is not operated in the signal triggered mode the controls for time base B trigger will be disabled resp. are only for time base A.

30.1.7 A variable - On Off

If "On" was selected the TIME/DIV-SCALE-VAR knob will function as variable control for the time base A speed. Only in time base A only mode this option will be available in the menu.

For a full description see "28.1.3 Variable".

30.1.8 B variable - On Off

If "On" was selected the TIME/DIV-SCALE-VAR knob will function as the time base B variable control. For a full description see "28.1.3 Variable".

30.1.9 Holdoff ...%

In this mode the hold-off time may be selected from 0 to 100 % with the INTENS knob. Values > 0 extend the waiting time after a sweep before a new one can start and decrease thus the repetition rate which may darken the display. This is indicated by the HOLD OFF-LED lighting up. The hold-off time is only valid for time base A.

Further information can be found in the section "Hold-off adjustment" in the chapter "Triggering and time bases".

30.2. DSO mode

In the "Zoom" menu the following time base functions are available:

30.2.1 Off

In "Zoom Off" condition only time base A is active. The readout will thus only show "A..." in the top left corner. The speed can be set with the TIME/DIV-SCALE-VAR knob ⑳.

30.2.2 Search

Part of the time base A display will be intensified and this portion will also be displayed expanded over the full screen. With the HORIZONTAL knob ㉑ the intensified sector and the expanded display can be shifted provided that the pushbutton X-POS DELAY ㉒ is illuminated which means "Delay". The length of the intensified sector is determined by the speed of the Z time base. The Y position of both displays is identical so they are written one over the other. In order to separate them for better readability an artificial Y offset may be added to the Z time base display. Press the pushbutton CH1/2-CURSOR-CH3/4-MA/REF-ZOOM ㉓ to call the menu "Pos./Scale".

Then press the function pushbutton "Zoom". Now the POSITION 1 knob will function as Y position control for time base Z. As this only makes sense in "Search" mode it is unavailable in others.

30.2.3 Zoom only

Only the Z time base will be displayed. The readout will hence only show "Z..." in the top left corner. The TIME/DIV-SCALE-VAR knob affects only time base B.

㉓ CH1 (pushbutton)

This pushbutton opens the "CH1" menu which contains the following options referring to CH1 ㉔ resp. to the signal on CH1.

31.1. AC DC

Pressing the pushbutton will switch from AC to DC or vice versa. The mode selected will be shown in the readout following the sensitivity setting: ~ is for AC and = is for DC.

31.1.1 DC coupling

The signal will be directly coupled, from the BNC connector via the attenuator to the vertical amplifier. The input resistance is 1 MΩ in all positions of the attenuator.

31.1.2 AC coupling

A capacitor is inserted between the BNC connector and the attenuator, blocking the DC content of the signal and creating a low frequency cut-off at approx. 2 Hz. This will affect the shape and amplitude of signals with low frequency content. If the DC content of the signal changes or the duty cycle of pulses the capacitor will charge or discharge, this will cause a momentary Y shift of the display.

31.2 Ground On Off

The pushbutton will either connect the amplifier to the signal or to ground. If set to Ground the readout will show a ground symbol following the sensitivity setting, at the same place where formerly the coupling was indicated. In the Ground position and with automatic triggering a trace will be visible, this is handy for setting the Y position of it e.g. to the screen centre without disconnecting the signal. The readout will show a symbol (⊥) for 0 V which will be close to the vertical centre line of the graticule, it is the zero reference for any measurements. After switching back to the signal its amplitude can now be determined with respect to the formerly set zero reference.

31.3 Invert On Off (unavailable in analog XY mode)

This pushbutton will alternate between not inverted or inverted of the CH1 signal. The readout will indicate an inverted display by placing a bar above the CH1. The trigger signal derived from CH1 will not be affected by an inversion.

31.4 Probe submenu

Pressing the pushbutton will open the "CH1 probe" submenu.

31.4.1 *1 - *10 - *100 - *1000

A selection of probe attenuation factors from 1 to 1,000 is possible. The value selected will be automatically taken into account regarding the sensitivity indicated and measurements.

31.4.2 Auto

If Auto is selected HAMEG probes with automatic probe identification connectors will be recognized by the scope and the appropriate factor taken into account. The factor recognized will be indicated following "auto".

Probes without that special connector will cause the display "auto *1" and treated as 1:1 probes.

31.5 Variable On Off

If activated VAR on the CH1 pushbutton ㉕ will be illuminated. The readout will replace ":" by ">" (e.g. "CH1>5mV".) and this also in any cursor measurements pointing out that the sensitivity is uncalibrated.

The VOLTS/DIV-SCALE-VAR knob ㉖ will function as variable which can change the sensitivity continuously between 1 mV/cm to > 20 V/cm.

㉔ VERT/XY (pushbutton)

This pushbutton switches the "vertical" menu on/off. This menu allows to select the operating modes of the vertical amplifiers.

32.1 CH1

If "CH1" is selected only CH1 will be turned on, the mode is Yt. Also the readout will only display the parameters of CH1. (sensitivity, inverted/not inverted, coupling.) Although CH2 will not appear in the readout it may be used e.g. as a trigger input. Its controls are active but are not shown.

32.2 CH2

If "CH2" is selected only CH2 will be active, it is Yt mode, and only its parameters will be shown in the readout. Although CH1 will not appear in the readout it may be used e.g. as a trigger input. Its controls are active but are not shown.

32.3.1 DUAL trace alt./ chop

In dual trace mode both channels are turned on and the parameters of both are shown in the readout. Between the sensitivity indications there is an indication whether alternate "alt." or chopped "chp" mode is active. Normally, the mode will be automatically set by the time base speed selection, but it may be directly set using the function pushbutton. For time base speeds of 500 ms/cm to 500 μs/cm chopped will be used, from 200 μs/cm to 50 ns/cm alternate. This refers to unmagnified time bases. Alternate is the preferred mode, at any time one channel is displayed for a full sweep, after each sweep the other channel has its turn. At slow sweep speeds this will cause annoying flicker, at still slower ones the channel switching becomes visible. Here, the chopped mode steps in, both channels are switched at some high frequency so they are both visible at any sweep speed. This is, however, not appropriate for fast sweep speeds as the switching may become visible and may interfere with the proper signal display.

32.3.2 DUAL (DSO mode).

In DSO mode there is an a/d converter for each channel so both are measured simultaneously. Hence no channel switching is necessary and no information pertaining to it is shown.

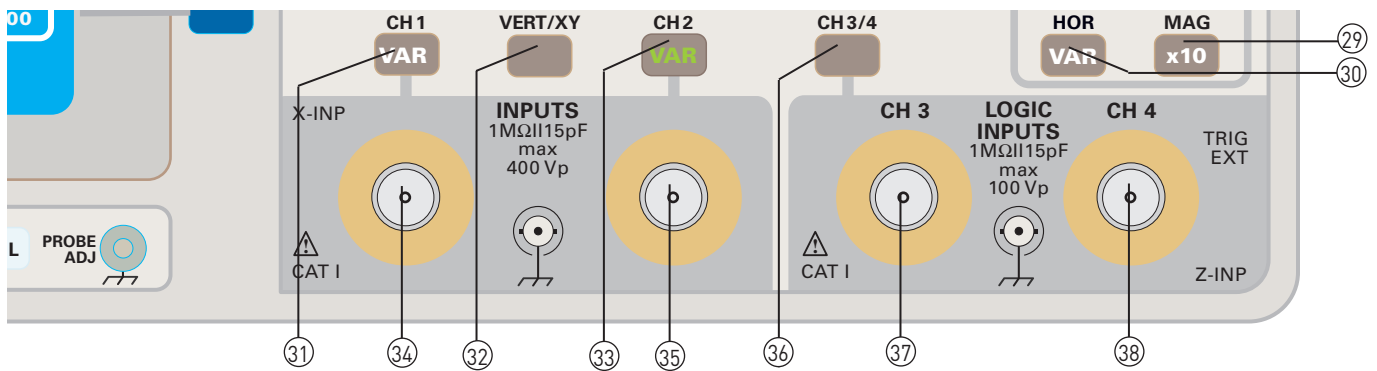

32.4 ADD

In ADD mode the signals of both channels are algebraically added and displayed as one sum signal. The Y position can be changed with both position controls. If one channel is inverted the difference will be displayed. Only one "0 V" symbol will be shown in the readout. The ADD mode will be indicated by placing a "+" symbol between the sensitivity indications of both channels. In DSO mode "1+2" will be displayed at the end of the trace.

Please note that the results of cursor measurements in this mode will only be correct if the sensitivities of both channels are identical, otherwise the readout will show "CH1<>CH2".

Automatic voltage measurements can not be performed in ADD mode. The readout will show "n/a" = not available.

As the trigger signals are taken off the inputs and not from the added signal there is no true reference for the trigger point symbol, the symbol will thus be switched off in analog mode. However, the LEVEL A/B control ⑨ is active.

In DSO mode a trigger time symbol is displayed one line above the lowest graticule line to indicate the trigger time position along the signal and thus can only be moved horizontally.

32.5 XY

In this mode CH1 will move the trace in X direction, hence the readout will show "CHX..", CH2 will move the trace in Y direction, hence "CHY..." will be shown rather than "CH2...".

As the time bases are not involved in XY no time base related information will be shown. Also the trigger circuits are disabled so no trigger information is shown, either.

The magnifier MAG x10 ⑳ is disabled. The "0-Volt" symbols will be shown as triangles at the right hand graticule and above the sensitivities.

Both the HORIZONTAL ⑳ or the POSITION 1 ⑬ knobs will move the trace horizontally. The Y position is controlled by the POSITION 2 knob.

32.5.1 Analog mode

The CH1 signal can not be inverted, there is hence no menu item in the CH1 menu [CH1 pushbutton ⑳]. The TIME/DIV-SCALE-VAR ㉔ knob is disabled.

Please note that the bandwidths and phase differences in XY analog and DSO modes differ considerably so there may be changes in the signal display when switching the mode.

32.5.2 DSO mode

The readout will indicate the sampling rate with which the A/D converters digitise the input signals. The appropriate sampling rate must be set depending on the signals and can be selected with the TIME/DIV-SCALE-VAR knob, although the time bases

are disabled. With high sampling rates there may be gaps in Lissajous representations. With too low sampling rates the display may not allow any more to determine the frequency relationship of the signals.

It is recommended to first look at the signals in DUAL mode and to set the sampling rate such that at least one signal period will be displayed. Then XY should be selected.

In XY DSO mode both channels may be inverted.

32.6 Bandwidth Full/20 MHz

This pushbutton will select full or 20 MHz bandwidth.

Full: Full bandwidth will be the one given in the specifications.

20 MHz: Provided measuring modes allow full bandwidth (i.e. ≥ 5 mV/cm) this can be reduced to 20 MHz (-3 dB) in order to attenuate high frequency noise e.g. The readout will show BWL = bandwidth limited. The bandwidth limitation affects both channels and pertains to analog and DSO modes.

In XY DSO mode the limitation is equal to Yt mode. In XY analog mode the limitation affects only CH2.

⑳ CH2 (pushbutton)

This pushbutton opens the CH2 menu which offers the following options:

33.1 AC DC

The pushbutton will alternate between AC and DC coupling. The readout shows a "~" or "=" symbol behind the sensitivity indication.

33.1.1 DC coupling

The signal will be directly coupled to the input amplifier via the BNC connector ⑤ and the input attenuator. The input resistance of the scope is a constant 1 M Ω irrespective of the sensitivity selected.

33.1.2 AC coupling

A capacitor is inserted between the BNC connector and the attenuator, thus the DC content of the signal is blocked and a high pass with a lower cut-off frequency of approx. 2 Hz is created. Low frequency signals will thus be more or less differentiated, hence their shape and amplitude affected.

If the DC content of the signal changes, e.g. the duty cycle of pulses, the capacitor must charge or discharge. This will cause a momentary Y shift of the display.

33.2 Ground (GND) On Off

The pushbutton will alternate between switching the amplifier input to the signal or to ground.

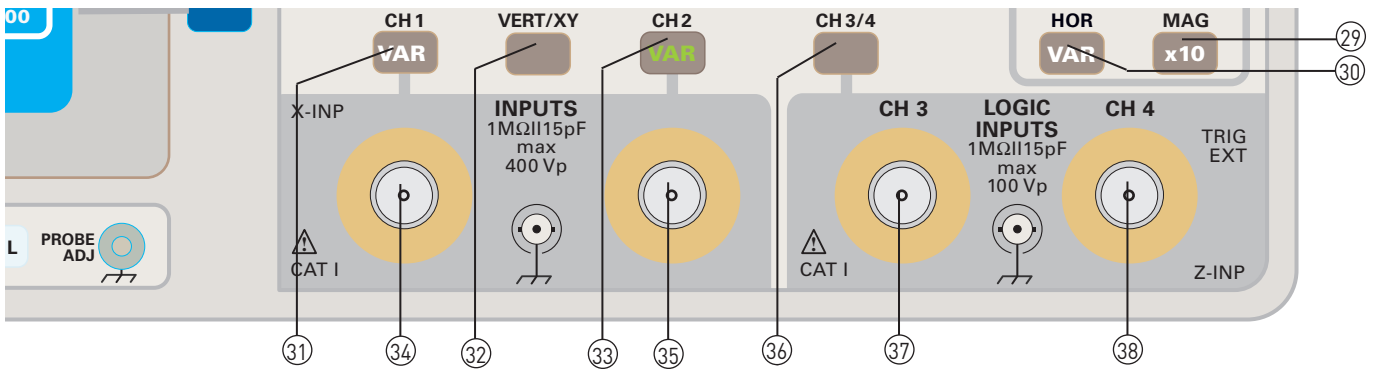

If the signal is disconnected resp. the amplifier input connected to ground the readout will show a ground symbol behind the sensitivity indication. In automatic trigger mode the trace will be visible in a reference position which can be used as a 0 V ground reference. The readout will show a symbol (⊥) for 0 V which will be close to the vertical centre line of the graticule, it is the zero reference for any measurements. Referred to the trace position 0 V a DC voltage may be measured after the input was returned to the signal.

33.3 Invert On Off

The pushbutton will alternate between not inverted and inverted. An inverted signal will be indicated in the readout by bar above the channel symbol. The trigger signal taken from an input will not be affected.

33.4 Probe menu

This pushbutton opens the "CH2 probe" submenu.

33.4.1 *1 - *10 - *100 - *1000

A selection of 4 factors can be made, the factor chosen will be automatically taken into account for all displays and measurements.

33.4.2 auto

If "auto" was selected HAMEG probes with special probe identification connectors will be automatically identified and the appropriate factor taken into account. The probe factor identified will be shown behind "auto".

Probes without that special connector will be treated as 1:1 probes (display "auto*1"), for those the factor must be manually set.

33.5 Variable On Off

If the variable is on VAR on the pushbutton will be illuminated and indicates that the sensitivity is now uncalibrated, the readout will show ">" instead of ":" (e.g. "CH2>5 mV") The results of cursor measurements will be identified accordingly. The VOLTS/DIV-SCALE-VAR knob (17) of CH2 has now the function of variable, the sensitivity can be varied between 1 mV/cm to > 20 V/cm.

34 INPUT CH1 (BNC connector)

This is the CH1 signal input connector. In Yt mode it is a Y input, in XY mode it is the X signal input. The connector housing is connected to the instrument housing and thus to safety ground. The ring around the connector is the probe identification contact, no voltage may be applied here.

35 INPUT CH2 (BNC connector)

This is the CH2 signal input connector. It is a Y input in Yt and XY mode. The connector housing is connected to the instru-

ment housing and thus to safety ground. The ring around the connector is the probe identification contact, no voltage may be applied here.

36 CH3/4 (pushbutton)

This pushbutton belongs to channels 3 and 4. The menu called by this pushbutton will depend upon the actual operating mode.



Attention!

If analog mode is present and "External" trigger SOURCE (22) is chosen, this pushbutton has no function and does not open a menu.

36.1 Analog mode.

CH3 has no function in analog mode.

36.1.1 CH4 (38) is the external trigger input. For setting external triggering press SOURCE (22), select the "Trig. Source" menu, then "External".

36.1.2 If "External" triggering was not selected the menu "Z Input" will open up. If "Off" is chosen CH4 has no function. If "On" is chosen it will function as Z input i.e. intensity modulation input. This input is destined for TTL signals, a voltage of > 1 V_p will turn off the trace.

36.2 DSO mode

Pressing the pushbutton CH3/4 will prompt the menu "CH3/4" in Yt mode. In XY mode the pushbutton is disabled. The CH3/4 menu offers:

36.2.1 Channels On Off

If "On" is chosen both channels 3 and 4 will be displayed, their BNC inputs (CH3 (37), CH4 (38)) serve as logic signal inputs. The channels are identified by CH3 resp. CH4 at the ends of their respective traces.

The Y positions can be controlled by the POSITION 1 and 2 knobs. In order to select this function proceed as follows: Press the CH1/2-CURSOR-CH3/4-MA/REF-ZOOM pushbutton (15) to call the "Pos./Scale" menu, select CH3/4.

Both channels measure the logic levels of applied signals using voltage comparators. Each comparator output is 1 bit. If "Off" is chosen both channels are off.

36.2.2 CH3 CH4

The pushbuttons selects either CH3 or CH4. This determines to which channel the settings of "Threshold" and "Probe" refer. CH3 and CH4 may have different level and probe settings.

36.2.3 Threshold

Calling this function will open the "CH3 Threshold" or "CH4 Threshold" submenus depending on the setting chosen above.

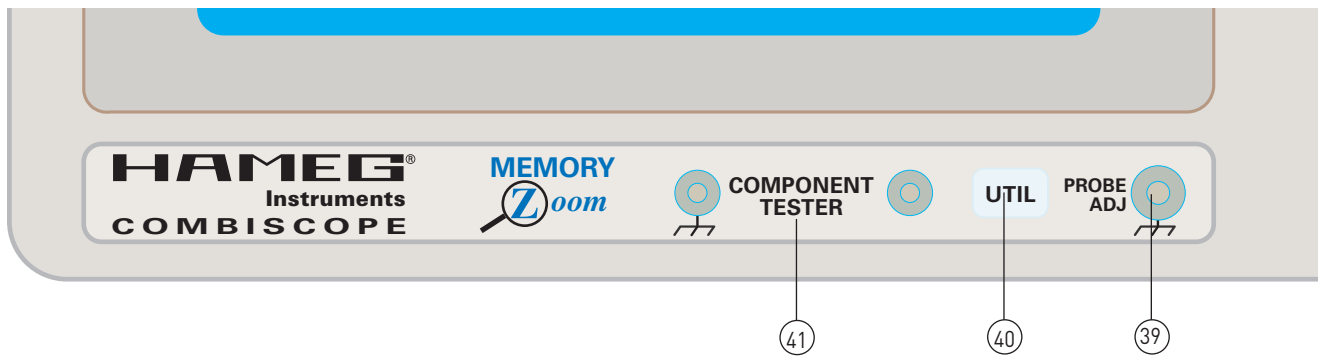

Each level menu (CH3 Threshold or CH4 Threshold) offers 6 thresholds, of which 3 are fixed ("TTL", "CMOS", "ECL"). 3 may be set, within certain limits, by using the INTENS knob ② ("User1", "User2", "User3").

For each of the logic signal inputs CH3 and CH4 a threshold level can be selected. Voltages \geq the level will be recognized and displayed as H.

The level indication takes the probe factor into account and always refers thus to the signal at the probe tip. Without probe (*1) the level can be chosen between $-1.9\text{ V} \dots +3\text{ V}$, with a 10:1 probe (*10) this corresponds to $-19 \dots +30\text{ V}$.

36.2.4 Probe

Depending on the menu actually on display the pushbutton will open the "CH3 probe" or the "CH4 probe" menu. Probe factors may be set there.

36.2.4.1 *1 - *10 - *100 - *1000

In the "CH3 probe" and "CH4 probe" submenus factors 1 – 10 – 100 – 1,000 may be chosen which will be taken into account by the instrument.

36.2.4.2 auto

If "auto" was selected HAMEG probes with automatic probe identification connectors will be recognized and the appropriate factor taken into account for definition of the switching level and the display.

Probes without probe identification connector will be treated as 1:1 probes (display: "auto*1").

⑳ Logic INPUT CH3 (BNC connector)

This BNC connector is the signal input to CH3 which allows the display of logic signals in Yt-DSO mode.

The connector housing is connected to the instrument housing and thus to safety ground. The ring around the connector is the probe identification contact, no voltage may be applied here.

㉑ LOGIC INPUT CH4 (BNC connector)

- In DSO mode this connector can be used as the signal input of CH4 or as external trigger input.
- In analog mode it can serve as external trigger or Z-axis (intensity modulation) input.

The connector housing is connected to the instrument housing and thus to safety ground.

The ring around the connector is the probe identification contact, no voltage may be applied here.

㉒ PROBE ADJ. (connector)

A square wave signal of 0.2 V_{pp} is available for the adjustment of 10:1 probes. The frequency can be selected by pressing the pushbutton "PROBE ADJ." and calling the menu "Utilities". Further information may be found in the section "Probe adjustment and use" in the chapter "Operation and presets".

㉓ PROBE ADJ (pushbutton)

This pushbutton produces the menu "Utilities", two options are available:

40.1 COMP. Tester On Off.

If "On" is chosen analog mode is selected automatically. A trace and a readout display "Component Tester" will appear.

In this mode the 4 mm connectors labelled "COMPONENT TESTER" become the measuring input. See also the chapter "Component Tester".

Choosing "Off" will return the instrument to all former settings.

40.2 Calibrator 1kHz 1MHz

Depending on the setting the square wave signal frequency at the PROBE ADJ – socket is 1 kHz or 1 MHz.

㉔ COMPONENT TESTER (sockets)

Both 4 mm diameter sockets serve as a two pole input for component test. Further information can be found under section Component Tester.

Oscilloscopes



Spectrum Analyzer

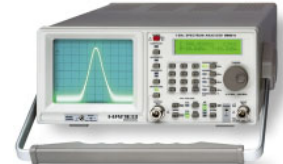

Power Supplies



Modularsystem
Serie s 8000



Programmable Instruments
Series 8100



authorized dealer



w w w . h a m e g . d e

Subject to change without notice
41-1508-00E0 / 14-02-2006-gw
© HAMEG Instruments GmbH
A Rohde & Schwarz Company
® registered trademark



DQS-Certification: DIN EN ISO 9001:2000
Reg.-Nr.: 071040 QM

HAMEG Instruments GmbH
Industriestraße 6
D-63533 Mainhausen
Tel +49 (0) 61 82 800-0
Fax +49 (0) 61 82 800-100
sales@hameg.de